

RCA

eiversatellitereceiversatellitere
eceiversatellitereceiversatellite
ereceiversatellitereceiversatellit
itereceiversatellitereceiversate
llitereceiversatellitereceiversat
tellitereceiversatellitereceiverd
satellitereceiversatellitereceive
rsatellitereceiversatellitereceiv
versatellitereceiversatelliterece
eiversatellitereceiversatellitere
eceiversatellitereceiversatellit
ereceiversatellitereceiversatellit
itereceiversatellitereceiversate
llitereceiversatellitereceiversat
tellitereceiversatellitereceiverd
satellitereceiversatellitereceive
ersatellitereceiversatelliterece
iversatellitereceiversatelliterece
ceiversatellitereceiversatellite
receiversatellitereceiversatelli
tereceiversatellitereceiversatel
littereceiversatellitereceiversat
ellitereceiver satellit
ereceiverdi sate
llitereceiver ve
rsatellit e r
eceive rsat
tellite recei
iversat ellit
terecei ve
ersatel



SAFETY INFORMATION

WARNING

To reduce risk of fire or shock hazard, do not expose this receiver to rain or moisture.

WARNING

RISK OF ELECTRIC SHOCK
DO NOT OPEN

TO REDUCE THE RISK OF ELECTRIC SHOCK, DO NOT REMOVE COVER (OR BACK). NO USER SERVICEABLE PARTS INSIDE. REFER SERVICING TO QUALIFIED SERVICE PERSONNEL.



This symbol indicates "dangerous voltage" inside the product that presents a risk of electric shock or personal injury.



This symbol indicates important instructions accompanying the product.

Cautions

Do not stack electronic components or other objects on top of the Digital Satellite Receiver. The slots on top of the receiver must be left uncovered to allow proper airflow to the unit. Blocking the airflow to the unit could impair performance or damage your receiver and other components.

Do not stack the digital satellite receiver on top of a "hot component" such as an audio power amplifier.

FCC Regulations state that unauthorized changes or modifications to this equipment may void the user's authority to operate it.

Note to Cable TV Installer:

This reminder is provided to call your attention to article 820-40 of the National Electrical Code (Section 54 of the Canadian Electrical Code, Part 1) which provides guidelines for proper grounding and, in particular, specifies that the cable ground shall be connected to the grounding system of the building as close to the point of cable entry as practical.

Note to Satellite Dish Installer:

This reminder is provided to call your attention to articles 810 and 820 of the 1999 National Electrical Code. Refer to article 810, in particular to 810-1 and 810-15, for required grounding of the metal structure of the Dish Antenna. Refer also to the 810-2 which, by reference to article 820, requires that the satellite dish coaxial cable shield be connected to the grounding system of the building as close to the point of cable entry as practical.

IMPORTANT NOTICE:

This device incorporates an anticopy process technology that is protected by U.S. patents and other intellectual property rights. The anticopy process is licensed for non-commercial, home use only. Reverse engineering or disassembly is prohibited.

Care and Cleaning:

Use a soft cloth or dusting attachment of your vacuum cleaner to dust your digital satellite receiver. Remove dust from the ventilation holes on the top and bottom.

Plastic surfaces are easily scratched and can be marred by alcohol and various solvents. Avoid excessive use of oil-based furniture polishes since the materials used in the cabinet will accumulate more dust. A non-abrasive, anti-static cleaner/polisher is recommended.

Product Registration

Please fill out the product registration card and return it immediately. Returning the card allows us to contact you if needed.

Keep your sales receipt to obtain warranty parts and service and for proof of purchase. Attach it here and record the serial and model numbers in case you need them. The numbers are located on the back of the digital satellite receiver.

Model No. _____

Serial No. _____

Purchase Date: _____

Dealer/Address/Phone: _____

TABLE OF CONTENTS

SETUP AND CONNECTIONS	3
Step 1: Unpack the DIRECTV PLUS™ System	4
Step 2: Connect Your Digital Satellite Receiver	4
Things To Know Before Connecting Components	4
Jacks and Cables	5
Back of the Digital Satellite Receiver	6
Top of the Digital Satellite Receiver	6
Basic Connection	8
Advanced Connection	10
Step 3: Place Batteries In the Remote Control	12
Step 4: Plug In and Turn On the Digital Satellite Receiver	12
Step 5: Connect the VCR Controller	12
Step 6: Using Point and Select	14
Step 7: Interactive Setup	14
Step 8: Order Programming	14
USING THE REMOTE	15
Remote Control Buttons	16
Programming the Remote Control	18
Testing the Remote Control	18
Using the Remote to Control a Device	19
Modes of Operation	19
Controlling a Second Satellite Receiver	19
Remote Control Codes	20
PROGRAM GUIDES	23
Anatomy Of a Program Guide	24
The Channel Banner	25
Using the GUIDE Button	26
Getting Around In the Guides	26
Tuning To a Program	27
Additional Program Guides	28
Sorting the Guides	30
THE MENU SYSTEM	35
Using the Menu System	36
The Program Guide	38
Messages	39

TABLE OF CONTENTS

Using the Purchases Menu	43
Reviewing and Canceling an Upcoming Purchase	43
Spending Limits	44
Pay Per View Programs	44
Previewing and Purchasing	45
Using the Attractions Guide	46
Timers Feature	47
Profiles	49
Creating a Profile Channel List	49
Setting the Rating Limit	50
Viewing Hours	51
Setting Up Spending Limits	51
Locking a User's Profile	52
Locking the System	52
Choosing Your Profile	54
Options	55
Interactive Setup	55
System Info	55
Look and Feel	56
System Options	58
Audio Language	60
Alternate Data	61
Upgrades	61
Dish Pointing	62
Selecting Dish Type	62
Find Your Dish Pointing Coordinates	63
Using the On-screen Signal Meter	64
TIPS & TROUBLESHOOTING	65
Troubleshooting	66
Finding the Video Input Channel On Your TV	68
How Signal Flow Works	69
Running the System Test	70
Fine-Tuning the Signal	70
APPENDIX A: WARRANTY INFORMATION	71
APPENDIX B: FCC REGULATIONS	74
APPENDIX C: ACCESSORIES	75
INDEX	77

SETUP AND CONNECTIONS

GETTING STARTED

This manual is designed to get you started quickly. The first three sections of the manual introduce you to your DIRECTV PLUS™ System.

In Setup and Connections, you'll learn:

- different ways to connect the digital satellite receiver to your TV
- how to order programming
- how to program the remote control

Using the Remote defines the buttons of the remote and how to program it to control other components.

Program Guides details the items and features associated with the different guides.

THE REST OF THE MANUAL

The rest of the book includes menu information, troubleshooting information (such as running a system test), and an index.

1 SETUP AND CONNECTIONS



2 USING THE REMOTE



3 PROGRAM GUIDES



4 THE MENU SYSTEM



5 TIPS & TROUBLESHOOTING

SETUP AND CONNECTIONS

STEP 1: UNPACK THE DIRECTV PLUS™ SYSTEM

Make sure to locate the remote control and VCR Controller.

STEP 2: CONNECT YOUR DIGITAL SATELLITE RECEIVER

During the satellite dish antenna installation, the digital satellite receiver may have been connected to your TV with just a coaxial cable for the system test. Depending on what components you have, another connection may provide better picture and audio quality. The following sections provide cable and connection information to help you decide what connection is best for you.

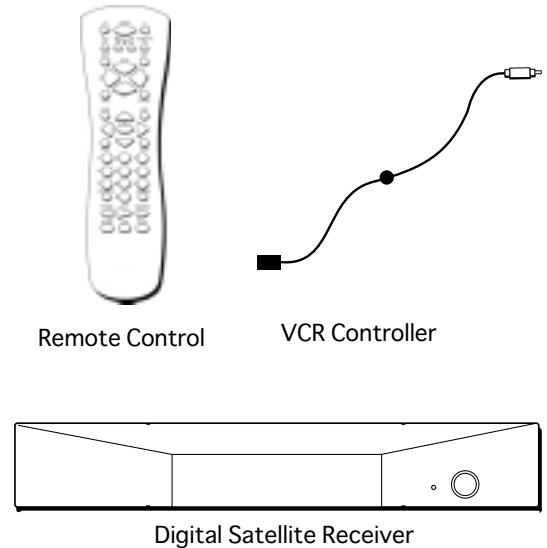

THINGS TO KNOW BEFORE CONNECTING COMPONENTS

Protect Your Components from Power Surges

- Connect all components before plugging any power cords into the wall outlet.
- Always turn off the digital satellite receiver, TV and other components before you connect or disconnect any cables.

Position Cables Correctly to Avoid Audio Hum or Interference

- Insert all cable plugs firmly into their jacks.
- Place the audio/video cables to the sides of the TV's back panel instead of straight down the middle after you connect your components.
- Try not to coil any twin-lead cables and keep them away from the audio/video cables as much as possible.
- Make sure all antennas and cables are properly grounded. Refer to the Safety Tips sheet packed with your unit.

Protect Your Components from Overheating

- Do not block ventilation holes in any of the components. Arrange the components so that air can circulate freely.
- Do not stack components.
- Allow adequate ventilation when placing your components in a stand.
- Place an amplifier or receiver on the top shelf of the stand so heated air rising from it will not flow around other components.

SETUP AND CONNECTIONS

JACKS AND CABLES

Below is a description of the jacks and cables you can use to make connections. Note that not all cables come with your DIRECTV PLUS™ System.

S-Video Jack and Cable

S-Video jacks provides the best picture quality for your DIRECTV PLUS™ System. S-Video jacks are available on many TVs and are used to carry visual information from the digital satellite receiver to your TV. Remember to connect the left and right audio cables because the S-Video jack carries only the picture signal, not the sound.

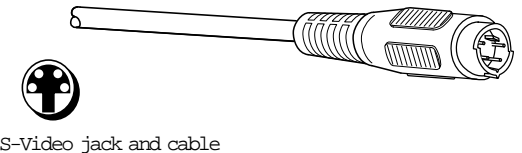

S-Video jack and cable

Audio/Video Jacks and Cables (RCA-type)

Audio/video jacks provide very good picture and stereo sound quality, and should be used if your TV has no S-Video jack. These jacks can also be used to connect other components. The digital satellite receiver audio/video jacks are color coded (yellow for video, red for right audio, and white for left audio). If your TV has only one input for audio (mono), connect it to the right (red) audio jack on the receiver.

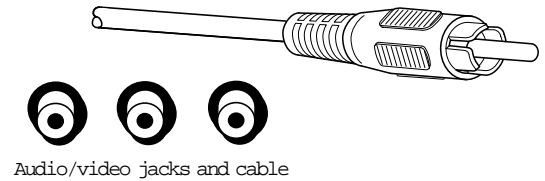

Audio/video jacks and cable

RF Jacks and Coaxial Cable (F-type)

The RF jacks provide good picture and mono sound quality, and are to be used if audio/video connections are not available on your TV. These jacks are also used for antenna and cable connections. The RF jacks on the receiver are labeled IN FROM ANT, OUT TO TV, and RF REMOTE. The coaxial cable supplied with your system is used to connect the receiver to your TV's antenna input jack.

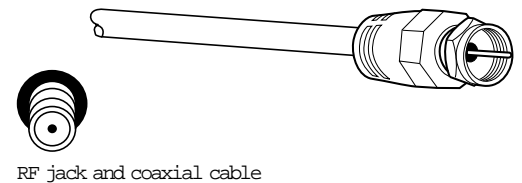

RF jack and coaxial cable

VCR Jack and Controller

The VCR Controller plugs into the VCR jack on the digital satellite receiver's back panel. Attach the other end of the cable to your VCR's remote control sensor.

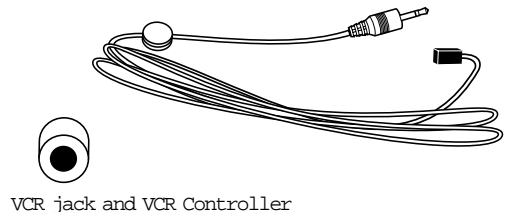

VCR jack and VCR Controller

Telephone Jack and Cord

The telephone line cord is required to connect your digital satellite receiver to a telephone line if you choose to subscribe to *DIRECTV® programming. The phone line connection is used to periodically call out to DIRECTV. You will need an RJ11-type modulator jack, which is the most common type of phone jack and might look like one of those pictured here. If you don't have a modular jack, call your local telephone company to find out how to get one installed.

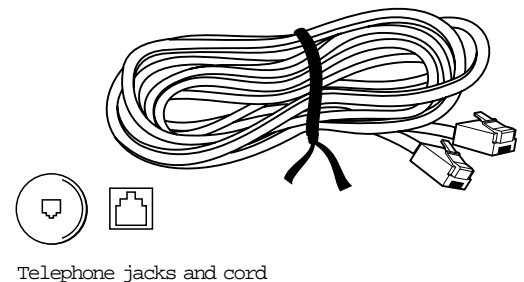

Telephone jacks and cord

*DIRECTV programming is provided in accordance with the terms and conditions of the DIRECTV Customer Agreement, which is provided with your first DIRECTV billing statement. DIRECTV is a trademark of DIRECTV, Inc., a unit of Hughes Electronics Corp., and is used with permission.

SETUP AND CONNECTIONS

BACK OF THE DIGITAL SATELLITE RECEIVER

The diagram below illustrates each of the back panel jacks found on your digital satellite receiver. When connecting A/V cables, be sure to connect corresponding **OUTPUTS** and **INPUTS** (Video to Video, Right Audio to Right Audio, etc.). For more information on the function of the back panel jacks and many other features of your digital satellite receiver, press the **MENU** button and select *Options* from the Main menu, then select *System Info*.

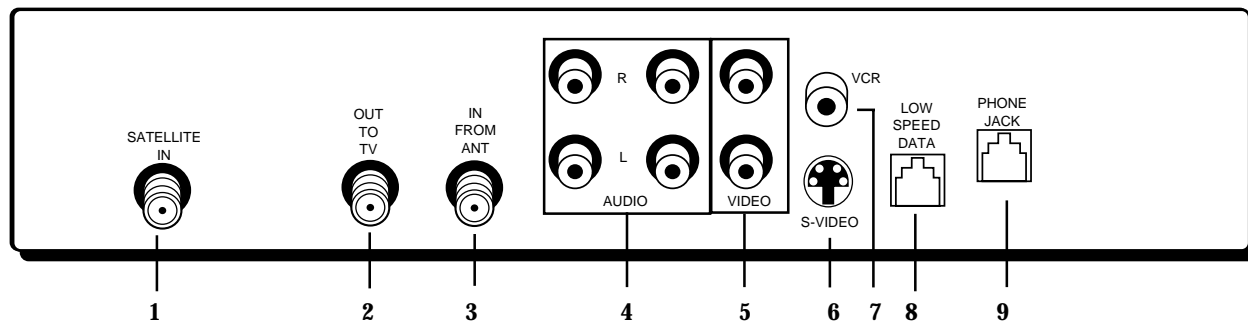

TOP OF THE DIGITAL SATELLITE RECEIVER

The diagram below illustrates the buttons on the top of your digital satellite receiver (also referred to as the front panel). For more information on the function of the front panel buttons and many other features of your digital satellite receiver, press the **MENU** button and select *Options* from the Main menu, then select *System Info*.

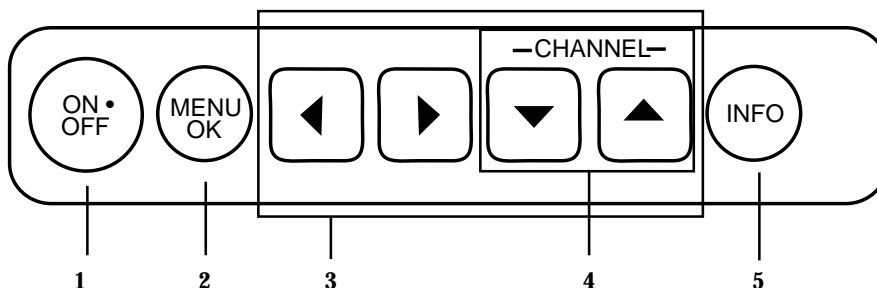

SETUP AND CONNECTIONS

Back of Digital Satellite Receiver Jacks

- 1 SATELLITE IN** Use to connect the digital satellite receiver to the satellite dish antenna.
- 2 OUT TO TV** Use to connect the digital satellite receiver to your TV. However, if your TV has audio/video jacks, you should use those jacks to get better picture and sound quality.
- 3 IN FROM ANT** Use to connect the digital satellite receiver to an off-air antenna or cable TV signal.
- 4 AUDIO (R and L)** Provide better sound quality than the OUT TO TV jack. If your TV has audio/video input jacks, use these jacks to connect the digital satellite receiver to your TV. Connect the second set to another device, such as a VCR. You must also connect the VIDEO or S-VIDEO jack.
- 5 VIDEO** Provides better picture quality than the OUT TO TV jack. If your TV has audio/video jacks, use this jack to connect the digital satellite receiver to your TV. Connect the second set to another device, such as a VCR. You must also connect the AUDIO jacks.
- 6 S-VIDEO** Provides the best picture quality. If your TV has an S-Video jack, use this jack along with the audio/video jacks to connect the digital satellite receiver to your TV.
- 7 VCR** Use to connect the VCR Controller to your digital satellite receiver. Attach the other end to the IR sensor on your VCR. This connection lets you use the One-Touch Record and Timer recording features.
- 8 LOW SPEED DATA** This port allows you to connect your DIRECTV System to future services and accessories as they become available. A shielded cable and additional hardware may be required.
- 9 PHONE JACK** Use to connect the digital satellite receiver to a telephone line. The DIRECTV System requires a telephone line connection to periodically call out to program providers. If you subscribe to Caller ID through your telephone company, you must also make sure your phone line connection is direct and to a non-wireless jack.

Top of Digital Satellite Receiver Buttons

- 1 ON•OFF** Use to turn your digital satellite receiver on for viewing or off when you are not viewing it. Your receiver will still be able to download software upgrades and receive messages from program providers when it is off.
- 2 MENU OK** Use this button to display the Main menu. If you are already in the menu system, pressing this button selects the highlighted item.
- 3 Arrows** Use these buttons to navigate left and right, down and up, in the menu system.
- 4 Channel Down and Up** When you're watching TV, use these buttons to change the channel. When you're in the menu system, use these buttons for navigation.
- 5 INFO** Use this button to display the channel banner, password challenge, or purchase offer screen. Press twice to display additional program information, when available.

SETUP AND CONNECTIONS

BASIC CONNECTION

This connection provides a basic level of sound and picture quality and can be used with TVs and VCRs that do not have audio/video jacks.

CAUTION

Do not stack electronic components or other objects on top of the digital satellite receiver. See "Safety Information," inside the front cover.

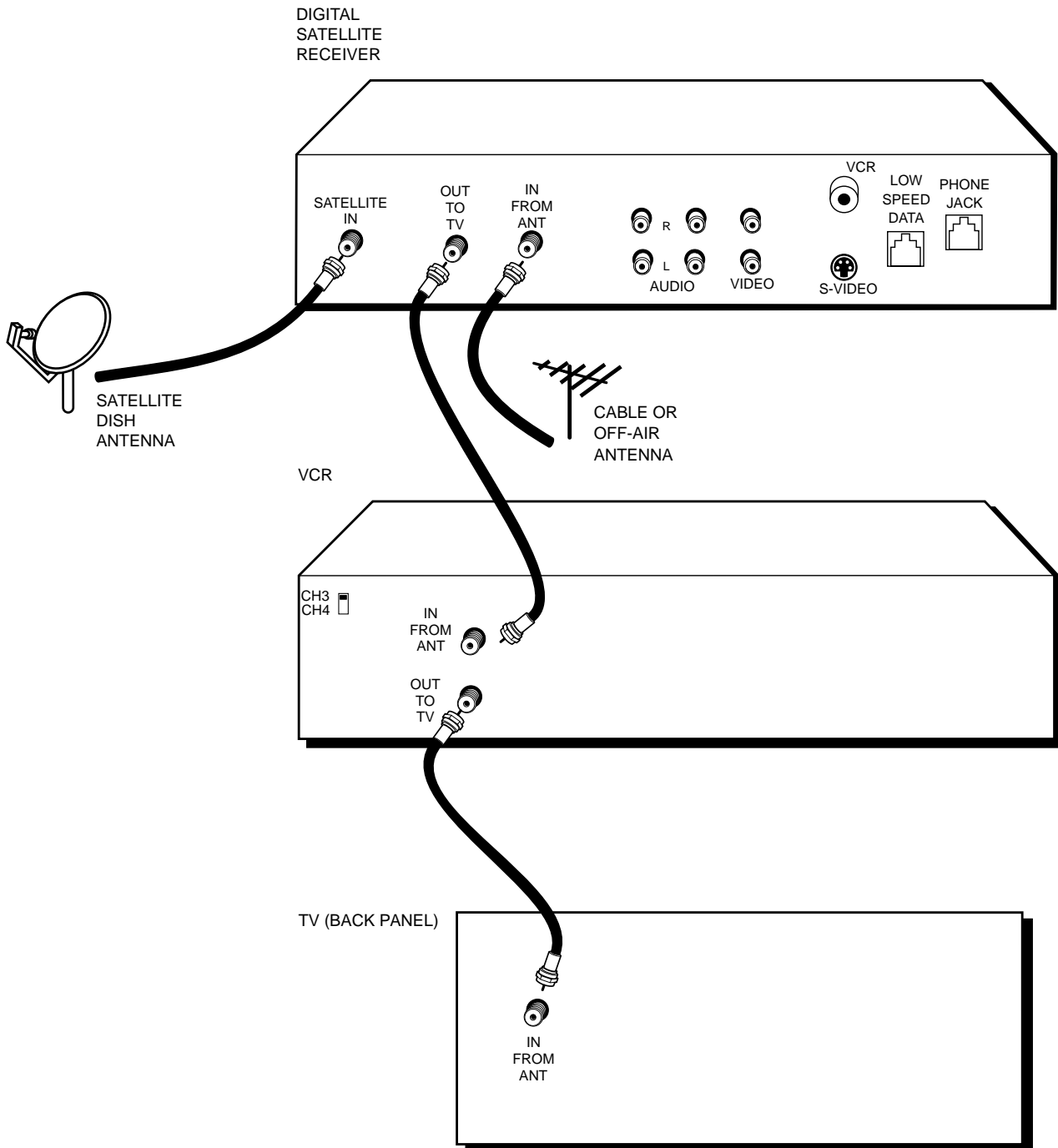

SETUP AND CONNECTIONS

What You Need

- Three coaxial cables
- One RG-6 coaxial cable

Making the Connection

1. Connect the OUT TO TV jack on the digital satellite receiver to the IN FROM ANT jack on the VCR with a coaxial cable.
2. Connect the OUT TO TV jack on the VCR to the TV's IN FROM ANT jack with a coaxial cable.
3. Connect the SATELLITE IN jack on the digital satellite receiver to your satellite dish antenna with an RG-6 coaxial cable.
4. Connect the IN FROM ANT jack on the digital satellite receiver to your cable box or off-air antenna with a coaxial cable.

Using Your Components

To watch DIRECTV® programming:

Tune the TV to either CH 3 or 4. (The default is CH 3. You can change the output channel to 4 by choosing *Options* from the Main menu, then *System Options*, and then selecting *Output Channel*.)

To record DIRECTV® programming:

Tune the digital satellite receiver to the desired channel and set your VCR to record on channel 3 or 4.

To view VCR recordings:

Tune the TV to the VCR output channel (usually CH 3 or 4) and set your VCR to play. If your VCR is a brand other than RCA, GE, or PROSCAN, you may need to program the remote to control the VCR. See the "Using the Remote" section for more information.

SETUP AND CONNECTIONS

ADVANCED CONNECTION

This connection provides better sound and picture quality than the basic connection and is recommended for use with TVs and VCRs or other components that have audio/video jacks.

S-Video provides the best picture quality and is recommended for use with components that have S-Video jacks. If you use the S-Video cable, remember to connect audio cables as well. S-Video must be used with audio cables in order for you to receive sound.

CAUTION

Do not stack electronic components or other objects on top of the digital satellite receiver. See "Safety Information," inside the front cover.

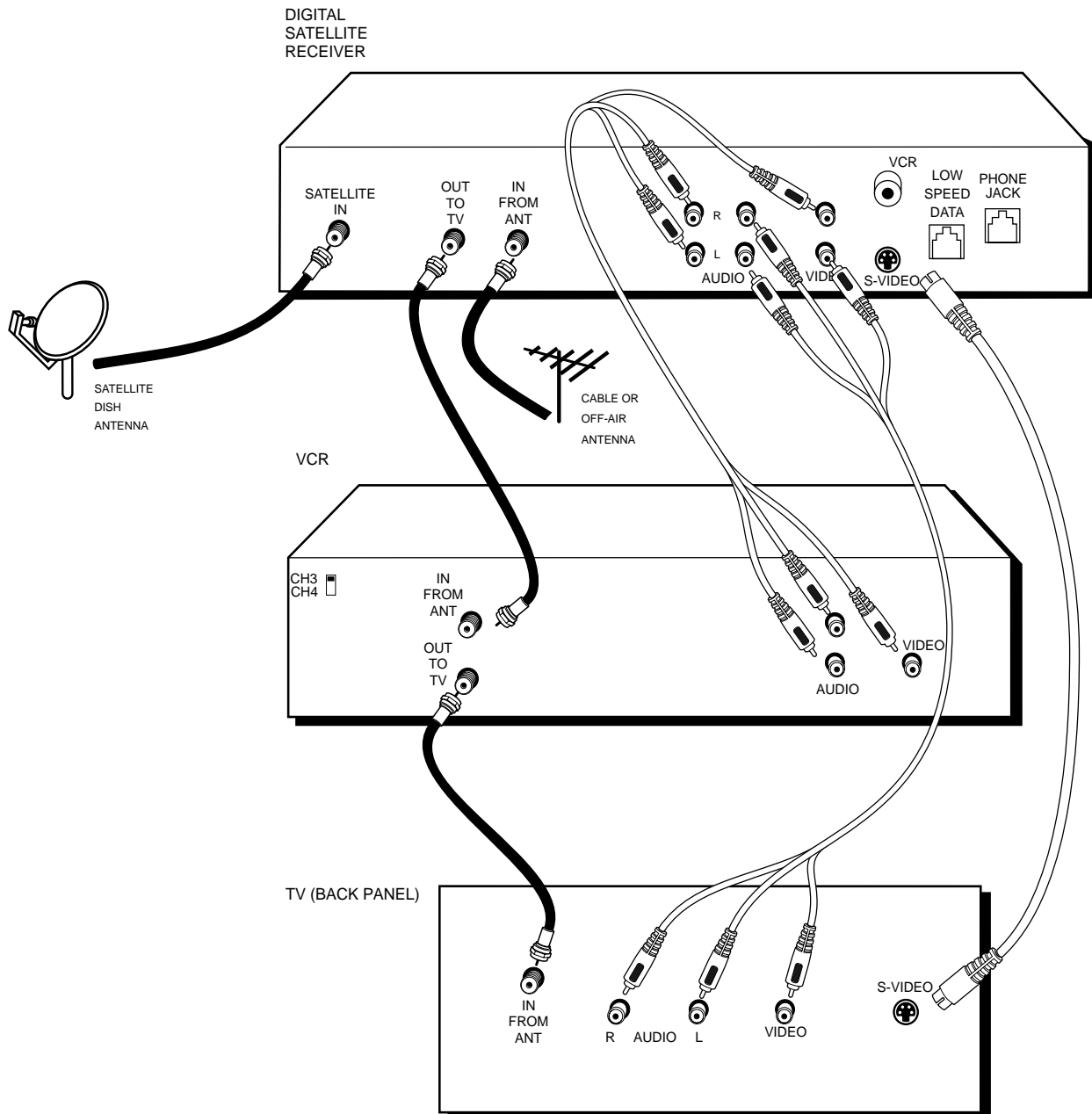

SETUP AND CONNECTIONS

What You Need

- Three coaxial cables
- One RG-6 coaxial cable
- Two sets of audio/video cables
- One S-Video cable (optional)

Making the Connection

1. Connect the OUT TO TV jack on the digital satellite receiver to the IN FROM ANT jack on the VCR with a coaxial cable.
2. Connect the OUT TO TV jack on the VCR to the TV's IN FROM ANT jack with a coaxial cable.
3. Connect the SATELLITE IN jack on the digital satellite receiver to your satellite dish antenna with an RG-6 coaxial cable.
4. Connect the IN FROM ANT jack on the digital satellite receiver to your cable box or off-air antenna with a coaxial cable.
5. Connect one set of AUDIO and VIDEO jacks on the digital satellite receiver to a set of AUDIO and VIDEO jacks on your TV using one audio/video cable.
6. Connect a second set of AUDIO and VIDEO jacks on the digital satellite receiver to a set of AUDIO and VIDEO jacks on another device, such as a VCR, using a second audio/video cable.
7. (optional) Connect the S-VIDEO jack on the digital satellite receiver to the S-VIDEO jack on the TV using an S-Video cable.

Using Your Components

To watch DIRECTV® programming:

Tune the TV to the video input channel. (If you have difficulty finding your TV's video input channel, follow the instructions in the "Tips and Troubleshooting" section.) Then tune the digital satellite receiver to the desired channel.

To record DIRECTV® programming:

Tune the digital satellite receiver to the desired channel. Then set your VCR to record on your video input channel.

To view VCR recordings:

Tune the TV to the video input channel and set your VCR to play. If your VCR is a brand other than RCA, GE, or PROSCAN, you may need to program the remote to control the VCR. See the "Using the Remote" section for more information.

SETUP AND CONNECTIONS

STEP 3: PLACE BATTERIES IN THE REMOTE CONTROL

Follow these steps whenever you need to install or change the batteries in your digital satellite receiver's remote control.

1. Remove the cover from the battery compartment.
2. Insert batteries in the battery compartment, matching the + and - end of each battery.
3. Replace the cover.

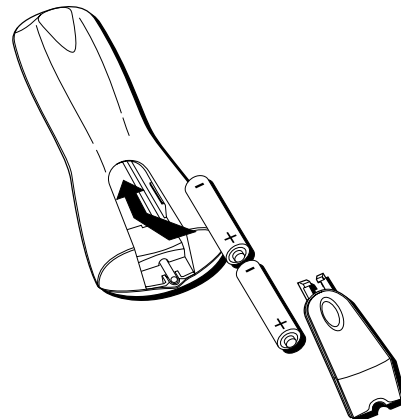

When replacing old batteries, note that you may have to reprogram your remote to control other devices.

STEP 4: PLUG IN AND TURN ON THE DIGITAL SATELLITE RECEIVER

Plug the end of the power cord into the wall outlet. Be sure to insert the plug completely.

To turn on the digital satellite receiver, press the DIRECTV button on the remote control or the ON•OFF button on the front panel. If your TV brand is RCA, GE, or PROSCAN, press the TV button on the remote to turn on the TV. If your TV brand is not RCA, GE, or PROSCAN, see the next section, "Using the Remote," for details on how to program the remote to control your TV.

STEP 5: CONNECT THE VCR CONTROLLER

In order for you to use the One-Touch Record and Timer recording features, you need to attach the VCR Controller to the back of the digital satellite receiver.

1. Plug the VCR Controller into the VCR jack on the digital satellite receiver.
2. Affix the other end to the remote control sensor on your VCR.

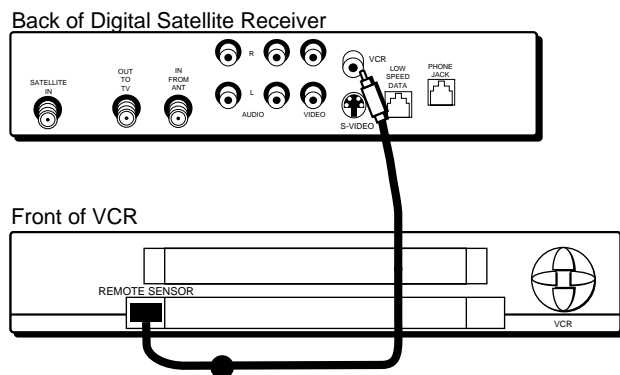

SETUP AND CONNECTIONS

LOCATING THE VCR'S INFRARED REMOTE CONTROL SENSOR

The VCR Controller must be affixed directly over the infrared remote control sensor on your VCR.

Some VCRs have a label that identifies the infrared remote control sensor, and others do not. If the IR sensor is labeled on your VCR, affix the VCR Controller directly over the sensor.

For VCRs that do not label the remote sensor, you need to use the VCR's remote to locate the sensor before affixing the VCR Controller.

1. Hold the VCR's remote control so that it is touching the front of the VCR.
2. Slowly move the remote over the front of the VCR while pressing the remote power button on and off.
3. When your VCR turns off or on, you have located the sensor.

To test the VCR controller, use a piece of clear tape to temporarily attach the VCR controller to the spot where you think the sensor is located, and then follow the steps under "Selecting a VCR Type."

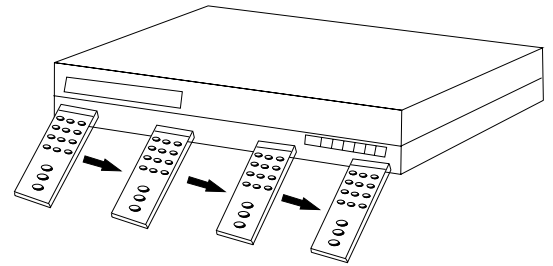

SELECTING A VCR TYPE

You need to tell the digital satellite receiver which VCR brand you are using.

1. Press MENU on the remote to bring up the Main menu.
2. Point to *Options* and press OK.
3. Point to *System Options* and press OK.
4. Point to *Set VCR Type* and press OK.

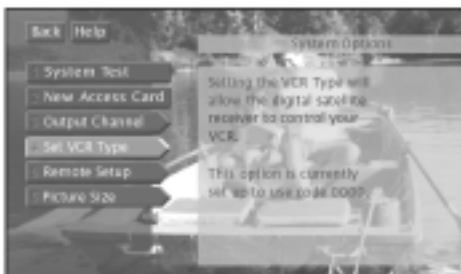

The *Set VCR Type* screen lets you enter a code for your VCR.

5. Use the arrows and the OK button to select the name of your VCR manufacturer.
 6. Follow the on-screen instructions to ensure that you are using the correct code.
- Some VCR brands may not be capable of being controlled by the receiver.

See Step 6, "Using Point and Select," for additional help on accessing and navigating the menu system.

If you do not see your VCR manufacturer's name, select *Other* (at the bottom of the list) and enter the appropriate code from the "Using the Remote" section.

SETUP AND CONNECTIONS

STEP 6: USING POINT AND SELECT

You only need to know one rule when using the remote to navigate on-screen menus and control panels: point and select. Once you know how to point and select you can complete the interactive setup (Step 7, below) and explore the menu system.

To enter the menu system, press the DIRECTV button on the remote control to make sure you're in DIRECTV mode, then press MENU.

The point and select method has two steps.

1. Point to a menu item using the arrows on the remote.

To point up or down, press the up or down arrows. To point left or right, press the left or right arrows.

2. Select a menu item by pressing MENU or OK.

Selecting an item tells the TV's menu system to go ahead and make the change or go to a place you have indicated.

Don't worry about getting stuck inside a menu. Pressing the CLEAR button on the remote control takes you out of the menu system and back to the program you were watching.

STEP 7: INTERACTIVE SETUP

If you installed your satellite dish antenna yourself, you may have already used the interactive setup to find the dish pointing coordinates, acquire and fine-tune the signal, and run a system test.

If you need to run the interactive setup again, select *Options* from the Main menu, then select *Interactive Setup*.

If you just want to check your dish pointing coordinates or run the signal strength meter, select *Dish Pointing* from the Main menu.

STEP 8: ORDER PROGRAMMING

After you have installed your DIRECTV System, you should contact DIRECTV in order to receive DIRECTV® programming.

Programming with DIRECTV: Call 1-800-347-3288

With this receiver and a DIRECTV PLUS™ satellite dish antenna, you may be able to receive local channels from DIRECTV in certain areas. Additional Equipment may be required in some areas. Check with your retailer or visit www.directv.com for information on availability of local channels from DIRECTV in your area.

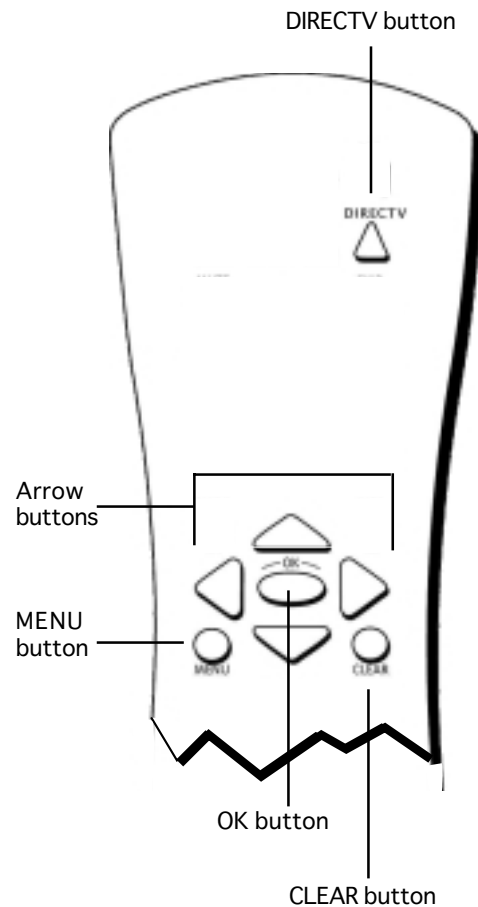

When you order programming, you need to know your access card number. To get the number, select *Options* from the Main menu, then *System Options*, and then select *System Test*.

Wait for the system to run all of its tests. The access card number is displayed at the end of the system test.

Write the access card number in the space below for easy reference:

USING THE REMOTE

HOW TO USE YOUR UNIVERSAL REMOTE

This section defines the buttons of the remote control and explains how to program it to control other devices.

The universal remote can be programmed to control most brands of remote controllable VCRs, TVs, and cable boxes. If you have an RCA, GE, or PROSCAN device, you probably don't need to program it at all.

1 SETUP AND CONNECTIONS



2 USING THE REMOTE



3 PROGRAM GUIDES



4 THE MENU SYSTEM



5 TIPS & TROUBLESHOOTING

USING THE REMOTE

REMOTE CONTROL BUTTONS

ON•OFF Turns the device you are controlling on or off. When pressed twice within two seconds, all devices that are on will be turned off (this feature only works with most RCA, PROSCAN, and GE products). You can also use the ON•OFF button on the top (front panel) of the digital satellite receiver to turn the receiver on or off.

VCR When programmed, tells the remote to control the VCR.

TV When programmed, tells the remote to control the TV.

DVD Tells the remote to control the DVD player. Note that this button is only functional with GE, RCA, and PROSCAN DVD players.

VCR2 When programmed, tells the remote to control a second VCR.

LED This light turns red at each valid button press. When programming the remote control, it flashes or turns on or off to indicate programming status.

AUX Acts as a “wildcard” button. It can be programmed to control another VCR, TV, satellite receiver or cable box. Or, it can be programmed to control an RCA, GE, or PROSCAN audio device. Follow the direct entry programming instructions, later in this section, to program this button.

DIRECTV Tells the remote to control the digital satellite receiver.

MUTE When programmed, reduces the TV’s volume to its minimum level. Press again to restore the volume.

SKIP This button is not used by the digital satellite receiver. It is functional only with RCA, GE and PROSCAN TVs and VCRs.

CH + (up) /- (down) Use to scan up and down through the channels in the current channel list. If you are in the program guide or menu system, use the CH +/- buttons to page up and down a screen at a time. You can also use the CH +/- buttons on the top of the digital satellite receiver to change the channel.

VOL down and up When programmed, adjusts the audio volume of your TV.

FETCH Either brings up the Fetch menu or tells the receiver to take the action you programmed it to take.

GO BACK Moves you back and forth between the last two selected channels. In the menu system, returns you to the previous screen.

GUIDE Brings up the program guide. Subsequent presses of the GUIDE button switch between the Detail and Grid guide formats.

INFO Brings up the on-screen channel banner, password challenge, or purchase offer screen. Press again to get program details. In the program guides, press to get information about the highlighted program or channel.

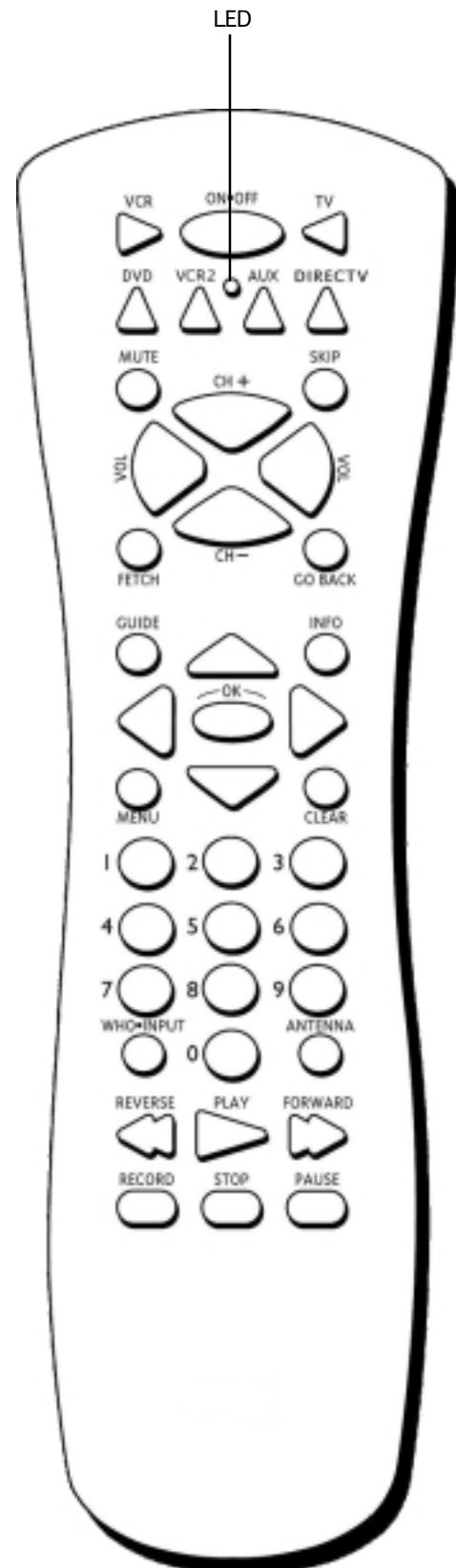

USING THE REMOTE

Arrows Use the navigation arrows to move the on-screen highlight up, down, left, or right. Using the arrows to highlight a menu item is also called “pointing.”

OK Selects a highlighted choice if you are in the menu system. After entering a one, two or three digit DIRECTV channel number, press to tune to the channel. If you are entering a number other than a DIRECTV channel number (for instance, to tune your VCR to a channel), you do not need to press this button.

MENU Displays the Main menu. If you are already in the menu system, press OK or MENU to select a highlighted choice. When you are using the remote control to operate an RCA, GE, or PROSCAN VCR (and the remote is in VCR mode), the MENU button functions as a PROGRAM button.

CLEAR Removes the on-screen displays and returns you to normal viewing.

Digit Buttons (0 - 9) Use the digit buttons to tune directly to a four digit DIRECTV channel or non-DIRECTV channel. If a DIRECTV channel number is less than four digits long, you must press OK after entering the channel number. If you are in the menu system, use the digits to highlight and select items (use 0 to return to the previous menu screen).

WHO•INPUT Press the WHO button one or more times to scroll through the user profiles. When you are using the remote control to operate an RCA, GE, or PROSCAN TV (in TV mode), press the WHO•INPUT button one or more times to scroll through the available video input sources.

ANTENNA In TV mode, lets you switch the source of the video signal from satellite signals to an off-air antenna or cable signal when using the OUT TO TV jack. In VCR mode, functions as a TV/VCR input button.

Transport Buttons (REVERSE, PLAY, FORWARD, RECORD, STOP, PAUSE) When programmed, these buttons are used to control an auxiliary device, such as a VCR or laserdisc player. Note that if your VCR Controller is connected, the RECORD button can be used to schedule a timer recording when using the Program Guide or to begin recording while watching a program (in VCR mode).

USING THE REMOTE

PROGRAMMING THE REMOTE CONTROL

The digital satellite receiver's remote can be programmed to control most brands of remote controllable devices. The remote is already programmed to control most RCA, GE and PROSCAN devices; it may need to be programmed to control other manufacturers' brands.

TESTING THE REMOTE CONTROL

To determine whether the universal remote control needs to be programmed, turn a device on, such as a VCR, point the remote at the VCR, and press the VCR button. Then press ON•OFF or CH + or CH - to see if the VCR responds to the remote commands. If not, the remote needs to be programmed.

There are two ways to program the remote control: automatic or direct entry.

Using Automatic Code Search

The following instructions can be used to program the remote to control many of the devices connected to your TV. If you want to exit the automatic code search without programming any of your devices, press the CLEAR button until the LED (red light) turns off.

1. Turn on the device you want to control (VCR, satellite receiver, etc.)
2. Press and hold the button you want to program. While holding the device button, press and hold ON•OFF until the LED on the remote turns on, then release both buttons.
- Note that the AUX button can only be programmed using direct code entry. See "Using Direct Entry," later in this section, for details.
3. Point the remote control at the device and press and release PLAY, then wait five seconds or until the LED stops flashing.

At this point the remote control is searching for the correct code to program. If, after five seconds, the device you want to control does not turn off, press and release PLAY again to tell the remote to search the next set of codes.

Continue pressing and releasing PLAY until the device turns off or you have searched through all of the codes. There are 20 total sets of codes. If the device does not turn off after pressing PLAY 20 times, then the remote cannot control that particular device.

If the device you want to control *does* turn off:

1. Press and release REVERSE, then wait two seconds. Repeat this step until the device turns back on.
2. To finish, press and hold STOP until the LED on the remote control turns off.

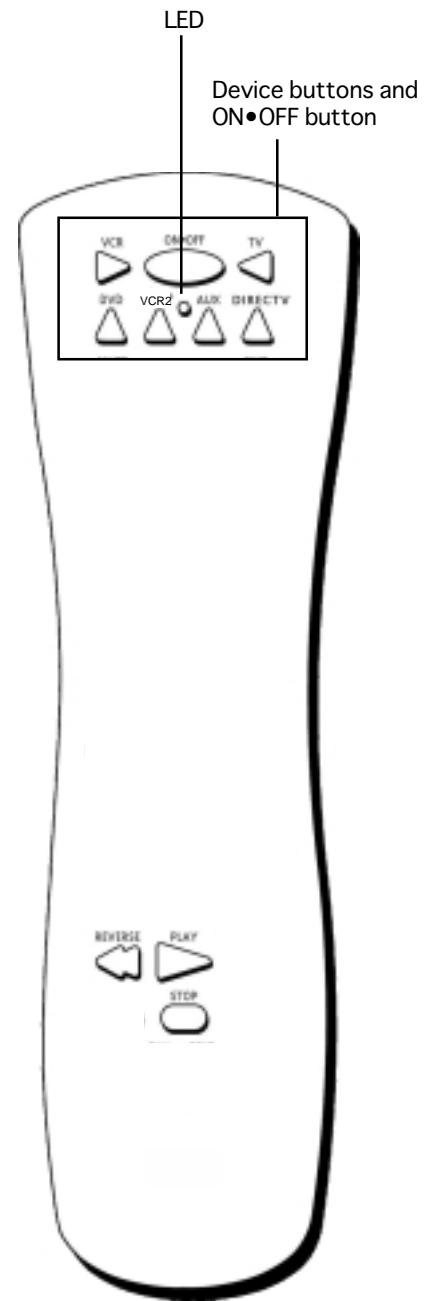

You'll use these buttons when you program the remote to control any device

The remote control may not operate all models of all brands.

USING THE REMOTE

Using Direct Entry

1. Turn on the device to be programmed.
2. Look up the brand and code number(s) for the device on the code list at the end of this section.
3. On your remote control, press and hold the device button you want to program.
4. Enter a code from the code list.
5. Release the device button, and then press ON•OFF to see if the device responds to the remote control commands. If it doesn't, try pressing the device button and then ON•OFF again.
6. If you get no response, repeat these steps using the next code listed for your brand, until the device responds to the remote control commands.

This remote control may not operate all models of the brands that are shown. Use the codes shown in this manual, or on the sheet packed with your remote.

USING THE REMOTE TO CONTROL A DEVICE

Once the remote has been programmed successfully, you are ready to use it to control your devices.

To operate the device:

1. Press the device button (TV, VCR, DIRECTV, VCR2, or AUX) to set the remote to control the device.
2. Press ON•OFF to turn the device on or off.
3. Use the remote control buttons that apply to that device.
 - If your remote is programmed to control a VCR, you only need to press the RECORD button to begin recording from video.

MODES OF OPERATION

Because this universal remote can control several different devices (DVD player, VCR, cable box, etc.) it uses operational modes triggered by the device buttons. For example, if you want the remote to control the TV, press TV to put the remote into TV mode. Then, if you want to play a videotape, press VCR, then PLAY (pointing the remote at the VCR).

CONTROLLING A SECOND SATELLITE RECEIVER

The remote can control two satellite receivers. From the Main menu, select *Options*, then *System Options*, then *Remote Setup*. Follow the on-screen instructions and enter the appropriate code from the Satellite Receiver list at the end of this section. By default, the DIRECTV button is used to control the first satellite receiver and the AUX button is used to control the second satellite receiver.

If your second receiver is an RCA, GE, or PROSCAN and you want to control it using the AUX button, use code 5001. Code 5000 is used by the DIRECTV button.

USING THE REMOTE

TV

Abex	1172
Admiral	1001, 1173
Adventura	1174
Aiko	1016
Akai	1002
Alleron	1046
Amtron	1038
AnamNational	1003, 1038
AOC	1004, 1005, 1006, 1007, 1175, 1176
Audiovox	1038
Belcor	1004
Bell & Howell	1001, 1083, 1162
Bradford	1038
Brokwood	1004
Cande	1004, 1006, 1008, 1174
Capehart	1175
Celebrity	1002
Centurion	1009
Citizen	1004, 1006, 1008, 1016, 1038, 1105, 1171, 1174, 1177
Clairtone	1176
Colortyme	1004, 1006
Concerto	1004, 1006
Contec/Cony	1012, 1013, 1014, 1038, 1176
Craig	1038
Crown	1038, 1171
Curtis Mathes	1000, 1004, 1006, 1015, 1105, 1162, 1171
CXC	1038
Daewoo	1004, 1005, 1006, 1016, 1017, 1018, 1127, 1171
Daytron	1004, 1006, 1171
Dimensia	1000
Dumont	1004, 1151
Dynatech	1178
Electroband	1002, 1176
Electrohome	1003, 1004, 1006, 1019, 1022
Emerson	1004, 1006, 1012, 1014, 1023, 1024, 1025, 1026, 1027, 1028, 1029, 1030, 1031, 1032, 1033, 1034, 1035, 1036, 1037, 1038, 1039, 1041, 1042, 1043, 1044, 1046, 1047, 1123, 1124, 1162, 1171, 1176, 1177, 1179, 1191
Envision	1004, 1006
Fisher	1048, 1049, 1050, 1051, 1162, 1180
Fujitsu	1046
Funcal	1038, 1046
Futuretec	1038
GE	1000, 1003, 1004, 1006, 1022, 1052, 1054, 1055, 1087, 1164, 1165, 1166, 1167, 1168, 1181
Gibraltar	1004, 1151
Goldstar	1004, 1005, 1006, 1012, 1019
.....	1056, 1057, 1058, 1155, 1156, 1171, 1172
Grundig	1038, 1046, 1171
Hallmark	1004, 1006
Harvard	1038
Hitachi	1004, 1006, 1012, 1013, 1059, 1060, 1061, 1135, 1136, 1137, 1138, 1139, 1140, 1141, 1142, 1143, 1144, 1145, 1146, 1148, 1150, 1179
IMA	1038
Infinity	1062
Janel	1174
JBL	1062
JCB	1002
JCPenney	1000, 1004, 1005, 1006, 1008, 1022, 1052, 1054, 1058, 1063, 1064, 1072, 1087, 1105, 1128, 1171, 1172, 1181
Jensen	1004, 1006
JMC	1012, 1013, 1054, 1060, 1065, 1066, 1067, 1089, 1157, 1158, 1159, 1182
Kawasho	1002, 1004, 1006
Kaypari	1175
Kenwood	1004, 1006, 1019
Kloss/Novabeam	1068, 1069, 1174, 1183
KTV	1038, 1070, 1171, 1176, 1177
Laewe	1062
Logik	1083
Luxman	1004, 1006
LXI	1000, 1006, 1049, 1062, 1071, 1072, 1073, 1162, 1181
Magnavox	1004, 1006, 1008, 1019, 1062, 1068, 1069, 1074, 1075, 1076, 1077, 1088, 1089, 1131, 1130, 1132, 1133, 1134, 1183, 1184
Maestic	1083
Marantz	1062
Marantz	1004, 1006, 1062, 1078
Megatron	1006, 1059
MEI	1176
Memorex	1001, 1006, 1082, 1083, 1162
MGA	1004, 1005, 1006, 1019, 1022, 1051, 1079, 1080, 1082
Midland	1054, 1151, 1171, 1172, 1181
Minutz	1052
Mitsubishi	1004, 1005, 1006, 1019, 1022, 1051, 1079, 1080, 1081, 1082, 1083, 1125
Montgomery Ward	1083
Motorola	1003, 1173
MTC	1004, 1005, 1006, 1105, 1176, 1178
Multitech	1038, 1178
Multivision	1084
NAD	1006, 1071, 1072, 1185
NEC	1003, 1004, 1005, 1006, 1089
Nikko	1006, 1016
NTC	1016
Orwa	1038
Optimus	1185
Optonica	1095, 1173
Orion	1035, 1191
Panasonic	1003, 1054, 1062, 1170
Philco	1003, 1004, 1005, 1006, 1008, 1012, 1019, 1062, 1068, 1069, 1074, 1075, 1077, 1183, 1184
Philips	1003, 1004, 1008, 1012, 1019, 1062, 1068, 1069, 1074, 1075, 1076, 1086, 1087, 1088, 1089
Pilot	1004, 1171
Pioneer	1004, 1006, 1090, 1091, 1092, 1179, 1185
Portland	1004, 1005, 1006, 1016, 1171
Price Club	1105
Prism	1054
PROSCAN	1000, 1181
Proton	1004, 1006, 1012, 1093, 1175
Pulsar	1151
Pulser	1004
Quasar	1003, 1054, 1070, 1094
RadioShack/Realistic	1000, 1004, 1006, 1012, 1038, 1049, 1095, 1162, 1171, 1172
RCA	1000, 1003, 1004, 1005, 1006, 1007, 1019, 1096, 1098, 1099, 1100, 1101, 1102, 1103, 1129, 1179, 1181, 1187, 1188, 1190, 1198, 1199
Rhapsody	1176
Runco	1151
Sampo	1004, 1006, 1171, 1172, 1175
Samsung	1004, 1005, 1006, 1012, 1015
.....	1019, 1104, 1105, 1106, 1171, 1172
Samsux	1171
Sansui	1191
Sanyo	1004, 1048, 1049, 1050, 1080, 1107, 1108, 1162, 1180, 1189
Scotch	1006
Scott	1004, 1006, 1012, 1024, 1035, 1038, 1046
Sears	1000, 1004, 1006, 1013, 1019, 1046, 1048, 1049, 1050, 1051, 1066, 1071, 1072, 1109, 1110, 1162, 1180, 1181, 1189
Sharp	1004, 1006, 1012, 1029, 1095, 1111, 1112, 1113, 1122, 1171, 1173
Shogun	1004
Signature	1001, 1083, 1115
Simpson	1008
Sonic	1176
Sony	1002
Soundesign	1004, 1006, 1008, 1038, 1046
Squareview	1189
SSS	1004, 1038
Starlite	1038
Supremacy	1174
Supreme	1002
Sylvania	1004, 1006, 1008, 1019, 1062, 1068, 1069, 1074, 1075, 1076, 1077, 1088, 1116, 1161, 1183, 1184
Symphonic	1033, 1038, 1189
Tandy	1173
Tatung	1003, 1178
Technics	1054
Techwood	1004, 1006, 1054
Teknika	1004, 1005, 1006, 1008, 1012, 1013, 1016, 1038, 1046, 1076, 1082, 1083, 1105, 1170, 1171
Telecaption	1117
TMK	1004, 1006
Toshiba	1049, 1071, 1072, 1089, 1105, 1109, 1117, 1118, 1160, 1162
Totevision	1171

USING THE REMOTE

Universal	1052, 1087
Victor	1066, 1182
Vidtech	1004, 1005, 1006
Viking	1174
Wards	1000, 1001, 1004, 1005
	1006, 1019, 1024, 1033, 1046, 1052
	1062, 1068, 1069, 1074, 1075, 1076, 1083
	1087, 1088, 1095, 1119, 1120, 1184
Yamaha	1004, 1005, 1006, 1019
Zenith	1004, 1083, 1151, 1152, 1153, 1154

VCR

Adventura	2026
Aiko	2027
Aiwa	0015, 2002, 2026
Akai	0003, 0017, 0022, 0023, 0063, 0066, 2003, 2004, 2005, 2007, 2008, 2111, 2112, 2113
American High	2021
Asha	2013
AudioDynamics	0014, 0016, 2009, 2010
Audiovox	2014
Bell & Howell	0002, 2011
Beaumont	2013
Broksonic	0010, 2012, 2025
Calix	2014
Cande	0007, 0009, 0013, 0044, 0045, 0046, 0052, 2013, 2014, 2015, 2016, 2017, 2018, 2019
Canon	0008, 0053, 2021, 2022, 2114
Capehart	0001, 2020, 2110
Carver	2062
CCE	2027, 2061
Citizen	0007, 0009, 0013, 0044, 0045, 0046, 0052, 2013, 2014, 2015, 2016, 2017, 2018, 2019, 2027
Colortyme	0014, 2009
Colt	2061
Craig	0007, 0012, 2013, 2014, 2023, 2061
Curtis Mathes	0000, 0007, 0008, 0014, 0015, 0044, 0046, 0053, 0064, 0067, 2000, 2002, 2009, 2013, 2016, 2018, 2021, 2022, 2024, 2115
Cybernet	2013
Daewoo	0013, 0045, 0052, 0076, 2015, 2017, 2019, 2025, 2026, 2027, 2028, 2110
Daytron	2110
dbx	0014, 0016, 2009, 2010
Dimensia	0000, 2000
Dynatech	0015, 2002, 2026
Electrohome	0027, 2014, 2029
ElectroPhonic	2014
Emerson	0008, 0009, 0010, 0013, 0015, 0020, 0023, 0027, 0034, 0041, 0042, 0047, 0049, 0057, 0062, 0065, 0067, 0068, 0070, 2002, 2012, 2014, 2015, 2021, 2024, 2025, 2026, 2029, 2030, 2032, 2033, 2034, 2035, 2036, 2037, 2038, 2039, 2040, 2041, 2042, 2044, 2045, 2047, 2065, 2105, 2113, 2116, 2117, 2130
Fisher	0002, 0012, 0018, 0019, 0043, 0048, 0058, 2011, 2023, 2048, 2049, 2050, 2051, 2052, 2118
Fuji	2021, 2119
Funai	0015, 2002, 2026
Garrard	2026
GE	0000, 0007, 0008, 0032, 0037, 0053, 2000, 2001, 2013, 2021, 2022, 2053, 2115, 2120
Goldstar	0009, 0014, 0046, 0060, 2009, 2014, 2018, 2054, 2121
Gradiente	2026
HarleyDavidson	2026
HarmanKardon	0014, 2009
Harwood	2061
Headquarter	2011
Hitachi	0005, 0015, 0035, 0036, 2002, 2055, 2056, 2057, 2107, 2111, 2120, 2122
Hi-Q	2023
Instant Replay	0008, 2021
JCL	0008, 2021
JCPenney	0002, 0005, 0007, 0008, 0014, 0016, 0030, 0035, 0051, 0053, 2009, 2010, 2011, 2013, 2014, 2021, 2022, 2055, 2056, 2058, 2059, 2060, 2107, 2118
Jensen	2055, 2056, 2111
JMC	0002, 0014, 0016, 0030, 0046, 0074, 2009, 2010, 2011, 2018, 2058, 2111, 2123
Kenwood	0002, 0014, 0016, 0030, 0044, 0046, 2009, 2010, 2011, 2016, 2018, 2058, 2111, 2123
KLH	0073, 2061
Kodak	2014, 2021

Lloyd's	0015, 2002, 2026
Logik	0031, 2061
LXI	2014
Magnavox	0008, 0029, 0053, 0056, 2021, 2022, 2062, 2063, 2104, 2108, 2124
Magrin	2013
Marantz	0002, 0008, 0014, 0016, 0029, 0030, 0044, 0046, 0061, 2009, 2010, 2011, 2016, 2018, 2021, 2058, 2062, 2064
Marta	0009, 2014
Masushita	2021
MEI	0008, 2021
Memorex	0008, 0009, 0012, 0015, 2002, 2011, 2013, 2014, 2021, 2023, 2026, 2104, 2131
MGA	0004, 0027, 2029, 2065, 2113
MGNTechnology	2013
Miland	0032, 2053
Minolta	0005, 0035, 2055, 2056, 2107
Mitsubishi	0004, 0005, 0027, 0035, 0040, 2029, 2055, 2056, 2065, 2066, 2067, 2069, 2070, 2071, 2072, 2073, 2074, 2106, 2113, 2123
Montgomery Ward	0006, 2075, 2131
Motorola	2021, 2131
MTC	0007, 0015, 2002, 2013, 2026
Multitech	0007, 0015, 0031, 0032, 2002, 2013, 2016, 2026, 2053, 2061
NEC	0002, 0014, 0016, 0030, 0044, 0046, 0059, 0061, 0064, 2009, 2010, 2011, 2016, 2018, 2058, 2064, 2076, 2078, 2079, 2111, 2123
Nikko	2014
Noblex	2013
Olympus	2021
Optimus	2014, 2131
Optonica	2096
Orion	2035
Panasonic	0008, 0053, 0075, 0077, 2021, 2022, 2109, 2125, 2126, 2127
Pentax	0005, 0035, 0044, 2016, 2055, 2056, 2107, 2120
PentaxResearch+	0046, 2018
Philco	0008, 0029, 0053, 0056, 2021, 2022, 2062, 2063
Philips	0008, 0029, 2021, 2062, 2096, 2124
Pilot	2014
Pioneer	0005, 0016, 0050, 2010, 2055, 2080, 2081, 2123
Portland	0044, 0045, 0052, 2016, 2017, 2019, 2110
PROSCAN	0000, 2000, 2001
Protec	2061
Pulsar	2104
Quarter	2011
Quartz	0002, 2011
Quasar	0008, 0053, 2021, 2022, 2125
RCA	0000, 0005, 0007, 0008, 0028, 0035, 0037, 0054, 0069, 2000, 2001, 2003, 2013, 2021, 2055, 2056, 2082, 2083, 2084, 2085, 2086, 2087, 2088, 2089, 2090, 2091, 2107, 2115, 2120, 2125
RadioShack	0002, 0006, 0008, 0009, 0012, 0015, 0019, 0027, 0043, 0053, 2002, 2011, 2013, 2014, 2021, 2022, 2023, 2026, 2029, 2049, 2050, 2096, 2131
Realistic	0002, 0006, 0008, 0009, 0012, 0015, 0019, 0027, 0043, 0053, 2002, 2011, 2013, 2014, 2021, 2022, 2023, 2026, 2029, 2049, 2050, 2096, 2131
Radix	2014
Randax	2014
Ricoh	2128
Runco	2104
Samsung	0007, 0013, 0022, 0032, 0042, 2005, 2013, 2015, 2033, 2053, 2112
Sanky	2104, 2131
Sansui	0016, 0071, 2010, 2092, 2111, 2123
Sanyo	0002, 0012, 2011, 2013, 2023
Scott	0004, 0013, 0041, 0049, 0068, 2012, 2015, 2025, 2032, 2035, 2038, 2065, 2093, 2116
Sears	0002, 0005, 0009, 0012, 0018, 0019, 0035, 0043, 0048, 2011, 2014, 2021, 2023, 2048, 2049, 2050, 2051, 2055, 2056, 2107, 2118
Sharp	0006, 0024, 0027, 0039, 0045, 2002, 2017, 2029, 2094, 2095, 2096, 2131
Shintom	0017, 0026, 0031, 0055, 2004, 2056, 2061, 2098
Shogun	2013
Signature	0015, 2002, 2131
Singer	2021, 2061, 2128
Sony	0017, 0026, 0038, 2002, 2004, 2098, 2099, 2119, 2128
STS	2021, 2107, 2021, 2107
Sylvania	0008, 0015, 0029, 0053, 0056, 2002, 2021, 2022, 2026, 2062, 2063, 2065, 2124

USING THE REMOTE

Symphonic	0015, 2002, 2026
Tandy	0002, 0015, 2002, 2011
Tashiko	0009, 2014
Tatung	0030, 2058, 2111
Teac	0015, 0030, 0069, 2002, 2026, 2058, 2085, 2111
Technics	0008, 2021, 2109
Teknika	0008, 0009, 0015, 0021, 2002, 2014, 2021, 2026, 2100, 2129
TMK	0067, 2013, 2024, 2047
Toshiba	0005, 0013, 0019, 0048, 0049, 2015, 2049, 2051, 2055, 2065, 2093, 2116
Totevision	0007, 0009, 2013, 2014
Unitech	0007, 2013
VectorResearch	0014, 0016, 0044, 2009, 2010, 2015, 2016
Victor	0016, 2010
VideoConcepts	0014, 0016, 0044, 2009, 2010, 2015, 2016, 2113
Videasonic	0007, 2013
Wards	0005, 0006, 0007, 0008, 0009, 0012, 0013, 0015, 0025, 0027, 0031, 0035, 2002, 2013, 2014, 2015, 2021, 2023, 2026, 2029, 2055, 2056, 2061, 2096, 2101, 2102, 2103, 2107, 2116, 2131
XR-1000	2021, 2026, 2061
Yamaha	0002, 0014, 0016, 0030, 0046, 2009, 2010, 2011, 2018, 2058, 2111
Zenith	0011, 0017, 0026, 0072, 0079, 2004, 2098, 2104, 2119, 2128

Cable Box

ABC	5002, 5003, 5004, 5005, 5006, 5007, 5053
Antronix	5008, 5009
Archer	5008, 5009, 5010, 5011
Cabletenna	5008
Cableview	5008
Century	5011
Citizen	5011
ColourVoice	5012, 5013
Comtronics	5014, 5015
Contec	5016
Eastern	5017
Garrard	5011
GC Electronics	5009
Gemini	5018, 5019, 5049
General Instrument	5003
Hamlin	5020, 5021, 5022, 5035, 5045
Hitachi	5003
Hytex	5002
Jaco	5011
Jerrold	5003, 5005, 5007, 5018, 5023, 5024, 5046, 5053
Magnavox	5025
Memorex	5026
MovieTime	5002, 5027, 5028
NSC	5002, 5027, 5028
Ock	5002, 5016, 5029
Panasonic	5048, 5052

Paragon	5026
Philips	5011, 5012, 5013, 5019, 5025, 5030, 5031, 5032
Pioneer	5033, 5034
Pulsar	5026
RCA	5047, 5049, 5052
Realistic	5009, 5049
Regal	5022, 5035
Regency	5017
Rembrandt	5003
Runco	5026
Samsung	5014, 5034
Scientific Atlanta	5006, 5036, 5037, 5038
Signal	5014, 5018
Signature	5003
SL Marx	5014
Sprucer	5052
Starcom	5007, 5018, 5053
Stargate	5014, 5018
Starquest	5018
Tandy	5040
Televue	5014
Tocom	5004, 5023, 5041
Toshiba	5026
Tusa	5018
TV86	5027
Unika	5008, 5009, 5011
United Artists	5002
United Cable	5053
Universal	5008, 5009, 5010, 5011
Videoway	5044
Viewstar	5015, 5025, 5027, 5040
Zenith	5026, 5050, 5051

Satellite Receiver

Chappard	5056, 5057
Drake	5058, 5059
GE	5000, 5001
General Instruments	5060, 5061, 5062
Panasonic	5075
Primestar	5076
PROSCAN	5000, 5001
RCA	5000, 5001
Realistic	5063
Sony	5072
STS1	5064
STS2	5065
STS3	5066
STS4	5067
Toshiba	5068
Toshiba	5073
Uniden	5069

PROGRAM GUIDES

WHAT IS A PROGRAM GUIDE?

A program guide is an on-screen programming schedule. There are several types of guides, each presenting the schedule in a different format.

Using the program guides is easy as long as you remember the Point and Select rule. Point to items on the screen by pressing the arrow buttons on the remote control or front panel. Then, press OK to tune to that program.

1 SETUP AND CONNECTIONS



2 USING THE REMOTE



3 PROGRAM GUIDES



4 THE MENU SYSTEM



5 TIPS & TROUBLESHOOTING

PROGRAM GUIDES

ANATOMY OF A PROGRAM GUIDE

The following diagram shows you the kind of information you will see in the program guides.

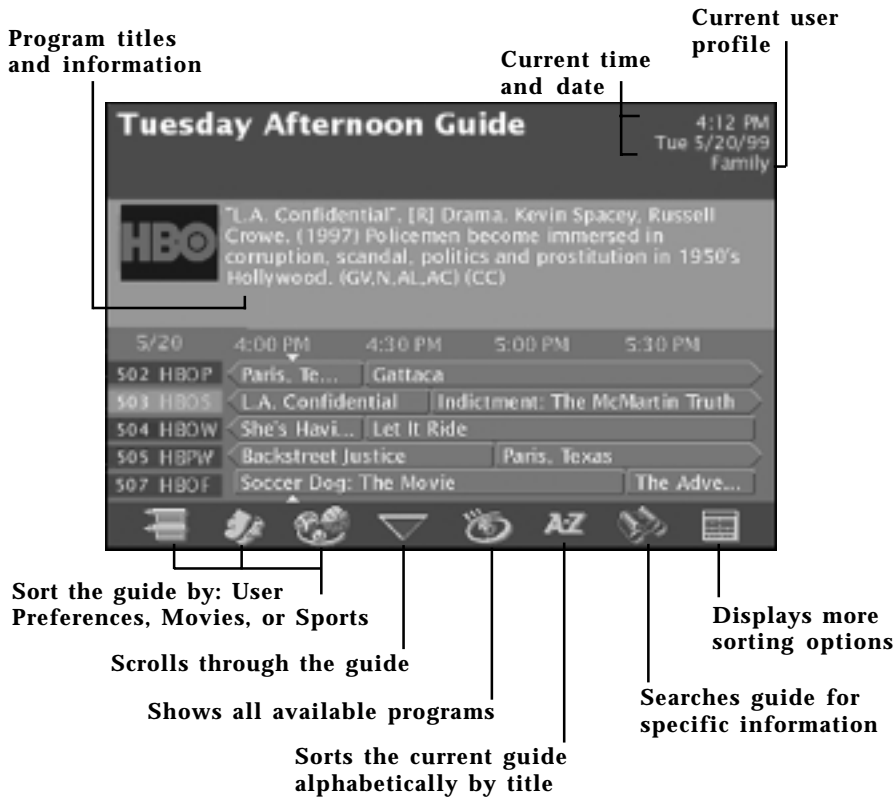

To change the current user, press the WHO•INPUT button while in a program guide.

BRINGING UP THE PROGRAM GUIDES

You can access the program guides by pressing MENU on the remote control and selecting *Program Guide*, or by using the GUIDE button on the remote.



PROGRAM GUIDES

THE CHANNEL BANNER

The channel banner appears whenever you do one of the following:

- tune to a channel
- press INFO, DIRECTV, AUX, or GO BACK from video
- exit a program guide or menu by selecting *Back*

On-screen icons represent frequently-used menu items. Some icons also change appearance to show the item's status. Use the arrow buttons and OK to choose an icon. Some of the items you select in the channel banner can also be selected in the program guides.

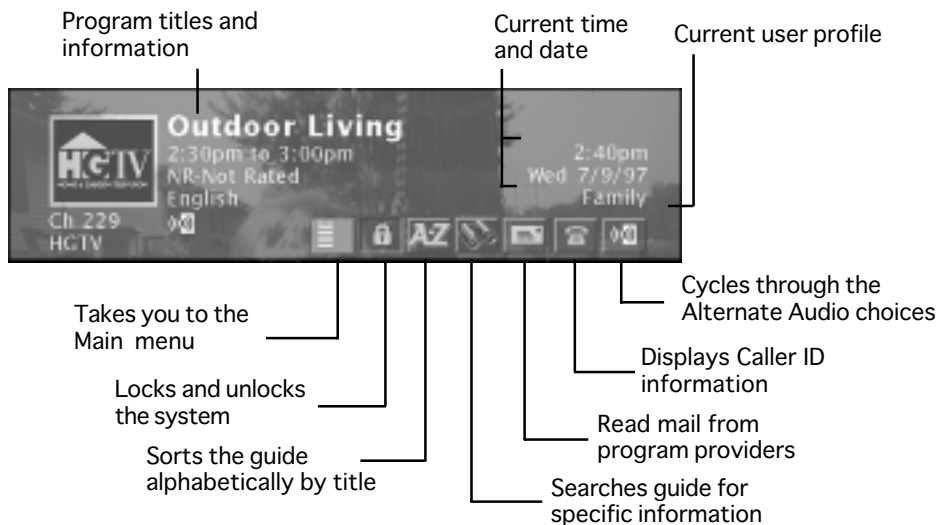

Main Menu icon When selected, takes you to the Main menu.

Green Unlock icon The system is unlocked. Spending, viewing and other limits can be accessed and changed.

Yellow Unlock icon A password has been entered to override family or profile limits. No limits can be accessed or changed.

Yellow Unlock icon with a "P" A password has been entered to override limits for the current program. After the program ends, limits are restored.

Red Lock icon No limits can be accessed or changed. A password is required to override spending, viewing, and other limits or access the menu system.

AlphaSort™ icon When selected, allows you to sort program titles alphabetically.

Scout™ (binoculars) icon When selected, allows you to use keywords to search for programs. The icon will be white if a Scout has found program information.

Mail icon When selected, takes you to the Mail screen. The icon will be white if you have an unread message or messages.

Telephone icon When selected, takes you to the Caller ID list screen. The icon will be white if you have received a new call but have not accessed the Caller ID List screen. It will be gray if you have accessed the Caller ID List screen.

Alternate Audio icon When selected, cycles through the alternate audio choices.

PROGRAM GUIDES

USING THE GUIDE BUTTON

Each time you press the GUIDE button, a different type of program guide appears.

The Detail Guide

The Detail Guide shows five channels in a time-and-channel format, with program information for the highlighted program.



Detail Guide

The Grid Guide

The Grid Guide shows seven channels in a time-and-channel format. A small window showing the program you were watching before entering the program guides is displayed in the upper left hand corner.



Grid Guide

GETTING AROUND IN THE GUIDES

This section describes how to change channels and move around a program guide.

Point to Channels With the Digit Buttons (0–9)

You can point quickly to any channel in the program guide by entering the channel number with the digit buttons (0–9) and pressing OK. For example, to point to channel 228, press the digits 2-2-8 then press OK on the remote control. If the number is four digits long, you don't have to press OK.

Scrolling Channel By Channel

The programs that you see on the TV screen make up one section—or page—of the total program guide. You can scroll to other pages using the arrows: point to other times with the left and right arrows; point to other channels with the up and down arrows.

Scrolling Page By Page

If you want to scroll up or down through the program guide faster, press the CH +/- buttons on the remote control. The highlight scrolls a page at a time.

By default, the Grid Guide appears when you press GUIDE on the remote. You can change the default guide from the Grid Guide to the Detail Guide.

Select *Options* from the Main menu. Select *Look and Feel*, then set the *Default Guide*.

PROGRAM GUIDES

TUNING TO A PROGRAM

To tune directly to a current program listed in the guide, point to the program and press OK.

To see information about a program in the guide, point to the program and press INFO.

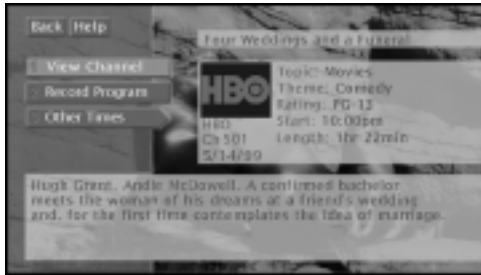

The Program Details screen gives you several options.

Then, you can select:

- *View Channel* to tune to that channel
- *Record Program* to record the program
- *Other Times* to see what other times the program is available. The program title is automatically entered and sorted in the AlphaSort control panel.

The options available to you may vary according to the type of program you select.

For information on tuning to a PPV program, see "The Menu System" section.

PROGRAM GUIDES

ADDITIONAL PROGRAM GUIDES

In addition to the Detail Guide and Grid Guide, there are a few more guides: the Channel Guide, the Logo Guide, and the Attractions Guide, plus the sorting variables Guide Data and Channel Groups.

You can access these guides and sorting variables by selecting the *Other Guides* icon at the bottom of the Detail Guide and Grid Guide.



Other Guides icon

The Channel Guide

Displays the programming schedule for the selected channel.



Scroll up and down to see programming information for the selected channel.

The Logo Guide

Displays channel logos for the current user's channel list.



The Logo Guide.

You can point to any program and tune to it or get more information. Just press the OK or INFO buttons.

Exiting A Program Guide

There are three ways to exit a guide (not all methods work in all guides):

- Point to a channel and press OK.
- Point to *Back* and press OK.
- Press CLEAR or GO BACK on the remote control.

PROGRAM GUIDES

The Attractions Guide

Displays a list of channels that show coming attractions and special events information.

Other Sorting Variables

The *Other Guides* icon also lets you sort the guide by different variables, such as future times (Guide Data), user profile channel lists, and channel groups. You can then choose a guide format to view the program information. For example, you could sort the guide by Pay Per View movies that will be available in the next five hours:

1. Select the *Other Guides* icon.
2. Select *Guide Data* and use the arrow buttons and the OK button on the remote control to choose +5.0 hours.

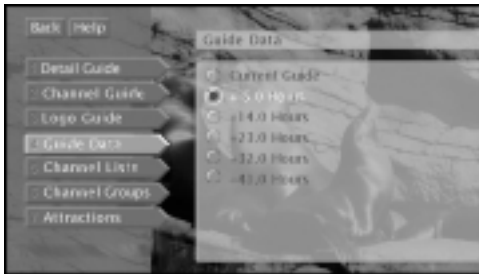

Guide Data lets you see what's on in the future.

3. Select *PPV* in the *Channel Groups* category.



Channel Groups is another way to sort programming.

Select *Back*, or press the GO BACK button on the remote control to return to the previous guide. You can also choose another guide format from the Other Guides menu.

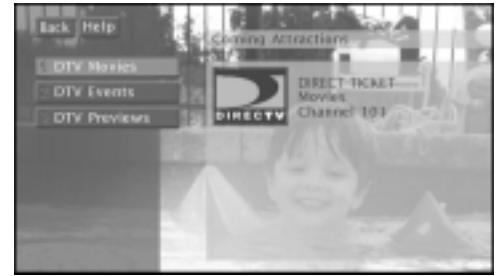

The Attractions Guide.

PROGRAM GUIDES

SORTING THE GUIDES

Sorting the guide is a way of organizing the guide to show only the types of programs that interest you. There are several on-screen icons that sort the guide in different ways.



The sorting icons appear at the bottom of the Grid Guide and Detail Guide.

User Preferences

The *User Preferences* icon sorts the guide according to the current user's preferences. The current user's profile name is displayed in the upper right of the Grid and Detail Guides and can be changed by pressing the WHO•INPUT button on the remote control. Select the *User Preferences* icon to sort the guide.

The *User Preferences* icon changes to the *Edit User Preferences* icon. Press the *Edit User Preferences* icon to edit the current user's themes preferences. These preferences are saved in each user's profile.



User Preferences icon



Edit User Preferences icon



Checkmark the themes that interest you.

Select the categories (topics), and checkmark the themes you would like to appear when you select the *User Preferences* icon in the guides. Only programming that fits the description of checkmarked themes will appear in the guide when you sort by the *User Preferences* icon.

To change the current user, press the WHO•INPUT button while in a program guide.

PROGRAM GUIDES

Movies

Select the *Movies* icon to list movies only. After selecting *Movies*, the *Movies* icon changes to a *Movies Themes* icon.

Select the *Movies Themes* icon to sort the guide to list specific types of movies, such as comedies or musicals. This icon may change from *Movies* to a different topic in the future, but it will continue to function in the same way.



Select a *Movies Theme* that interests you.



Movies icon



Movies Themes icon

Sports

Select the *Sports* icon to list sporting events only. After selecting *Sports*, the *Sports* icon changes to a *Sports Themes* icon.

Select the *Sports Themes* icon to sort the guide to list specific types of sports, such as basketball or soccer. This icon may change from *Sports* to a different topic in the future, but it will continue to function in the same way.



Select a *Sports Theme* that interests you.



Sports icon



Sports Themes icon

PROGRAM GUIDES

All

The *All* icon resets the guide to show all available topics, channels and listings for the current profile.



All icon

AlphaSort™

AlphaSort lists all the program titles in the current guide in alphabetical order. Select the *AlphaSort* icon to search for specific program titles that are in the current program guide in alphabetical order. Use the arrow buttons on the remote control to highlight a character, then press OK.



AlphaSort icon

For example, to search for the program *Auto Racing*, point to and select "A." (Words like "The," "A," and "An" appear at the end of a title.) All titles that begin with "A" appear in the *AlphaSort* list. Next, enter the letter "U." All titles beginning with "AU" appear in the list.

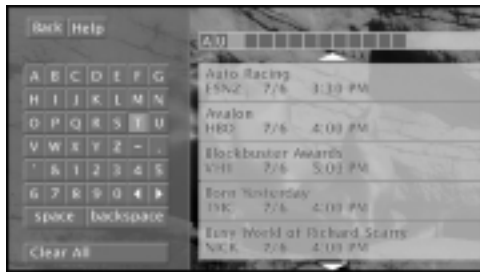

AlphaSort searches for specific titles in the guide.

Continue to enter the specific title until it appears in the *AlphaSort* list. If you enter the wrong character, select either *Backspace* or *Clear All*.

Use the arrow buttons on the remote control to highlight the title you are looking for. Press the OK button to select it, or the INFO button to see more information. AlphaSort can only find titles that are in the current program guide. For example, if you have sorted the guide to show only movies, AlphaSort will find only movie titles that match your entry.

PROGRAM GUIDES

Scout™

The *Scout* icon lets you assign “Scouts” to search the guide for specific program information, such as actors’ names or program descriptions.

Select the *Scout* icon from a program guide to view the available Scouts. Then, point to an available Scout (one without a checkmark by its name) and select it.

Select *Enter Text* to set up the information the *Scout* will look for in the program guide. Use the on-screen keyboard to enter the desired search parameters.

For example, if you are interested in how to prepare food, enter a common term you think would occur in program information, like “cooking.” When you have finished entering your topic select *Run Scout*.



Select Enter Text to set up a Scout.

If “cooking” appears within a program title or program description, the program will be included in the Scout Results program list.

(continued on next page)



Scout icon

On-screen icons represent the status of scout:



Indicates that a scout is set to find specific information.



Indicates that a scout has found the information you specified.

PROGRAM GUIDES

Once you have set up a Scout, you can check its status by highlighting that Scout. A highlighted binoculars icon means that a Scout has found results.

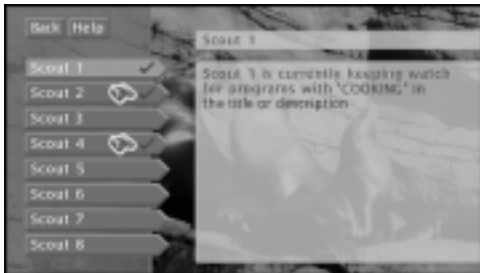

Scout 1 is in use, but has not yet found anything. Scouts 2 and 4 have results.

The Scout will search for information when the digital satellite receiver is off. (This may take up to 30 minutes for a full guide search.)

Check a Scout's results by selecting that Scout, then selecting *Scout Results*.

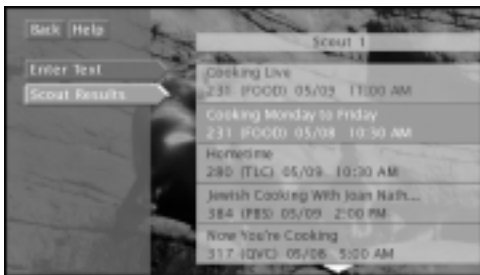

Scout results lists the Scout's findings.

Down Arrow

The down arrow icon allows you to scroll down through other channels in the guide. Point to the down arrow icon and then press OK to scroll down through the program guide.



Down Arrow icon

THE MENU SYSTEM

WHAT'S A MENU?

The on-screen menu is a list of choices, just like a menu in a restaurant. And, just as a restaurant menu is divided into sections such as appetizers, entrees, and desserts, the on-screen menus are also separated into sections to help you find the information you need.

DON'T FORGET POINT AND SELECT

As with all of the on-screen displays, you use Point and Select to navigate within the menu system.

1 SETUP AND CONNECTIONS



2 USING THE REMOTE



3 PROGRAM GUIDES



4 THE MENU SYSTEM



5 TIPS & TROUBLESHOOTING

THE MENU SYSTEM

USING THE MENU SYSTEM

To bring up the Main menu, press MENU on the remote control.



Use point and select to choose an item from the Main menu.

To use the menu system, you need to know the Point and Select rule: use the arrow buttons on the remote control to point to an item on the screen, and then press OK to select it. In numbered menus, use the digit buttons to select an item quickly.

BACK AND HELP

There are *Back* and *Help* buttons at the top of most screens. Point to *Back* and press OK to leave that screen. Point to *Help* to see more information about that screen.

Exiting a Screen

There are three ways to exit a menu:

- Point to *Back* and press OK.
- Press the CLEAR button on the remote control. The on-screen displays clear from the screen and you return to TV viewing.
- Press the GO BACK button on the remote control. You return to the previous on-screen display or normal programming.

Using Help

All menus have an on-screen *Help* choice available. For example, select *Help* from the Main menu to see information about using the Main menu screen.

The rest of the *Help* screens in the menu system contain helpful information explaining some aspects of that menu.

If the Main menu doesn't appear when you press MENU, the remote control might not be in DIRECTV mode. Press the DIRECTV button on the remote, then press MENU.

Context-Sensitive Help

Most of the screens contain information to help you decide what to do next. If you get stuck, look for the help text at the bottom of the screen.

THE MENU SYSTEM

MENU DESCRIPTIONS

This section briefly describes each of the available Main menu options. More information about each menu and its features is included later in this chapter.

Program Guide

Shows the on-screen programming schedules.

Messages

Access Caller ID information from your telephone company and mail messages from DIRECTV.

Purchases

Review or cancel upcoming purchases, review past purchases, and set spending limits.

Timers

Schedule the digital satellite receiver to tune to a specific channel at a specific time or to record future programming, if your VCR has been properly set up.

Profiles

Set system and user passwords, ratings limits, spending limits, and viewing hours, as well as create favorite channel lists.

Options

Find out more about the digital satellite receiver and remote control, change how your system looks, run the system test, and install a new access card.

Dish Pointing

Find your dish pointing coordinates and access the on-screen signal strength meter.

Back Help

1 Program Guide

2 Messages

3 Purchases

4 Timers

5 Profiles

6 Options

7 Dish Pointing

Don't Be Afraid to Explore

Once you've learned the basics, feel free to poke around the menu system—exploring is the best way to learn. The context-sensitive help at the bottom of the screen provides instructions for getting through any particular menu or control panel. Remember, press CLEAR at any time to leave the menu system and return to regular system viewing.

THE MENU SYSTEM

THE PROGRAM GUIDE

Selecting *Program Guide* from the Main menu brings up your default program guide: the Detail Guide or the Grid Guide.

1 Program Guide

ANATOMY OF A PROGRAM GUIDE

The following diagram shows you the kind of information you will see in the Detail Guide and Grid Guide (Detail Guide shown here).

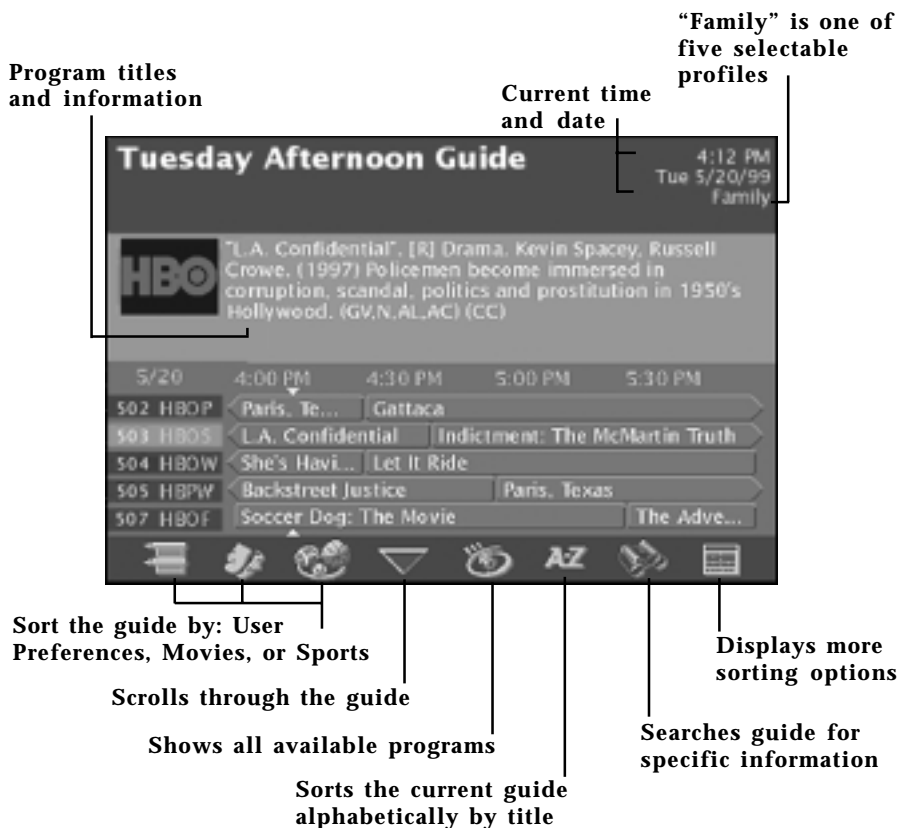

BRINGING UP THE PROGRAM GUIDES

In addition to selecting *Program Guide* in the Main menu, you can press the GUIDE button on the remote control.

Want More Information?

Read the "Program Guides" section in this book for all the details.

THE MENU SYSTEM

MESSAGES

2 Messages

The Messages menu lets you access messages or phone calls. If you select *Mail*, it shows you messages that are sent from DIRECTV. For example, you may receive a message calling your attention to a new service. If you select *Caller ID*, this menu shows you Caller ID information from your telephone provider (if you subscribe to Caller ID service).

MAIL

There are two ways to tell if you have mail, depending on whether the digital satellite receiver is turned on or off.

- If the digital satellite receiver is turned on, the mail icon in the channel banner is highlighted.
- If the digital satellite receiver is turned off, the light on the front panel of the receiver flashes.

Checking Your Mail

Select *Messages* from the Main menu, then *Mail* from the next menu. Or select the envelope icon on the channel banner to view your mail.

1. Point to a message and press OK. The message is opened for you to read.



Mail provides the latest information from program providers.

2. Press OK again to close the message.

If you want to erase a message after you read it, point to *Erase Message* and press OK. When you exit, messages that aren't erased are saved in memory.

THE MENU SYSTEM

CALLER ID

Your digital satellite receiver is capable of displaying and storing Caller ID information provided by your local telephone company. **To use this feature, you must have your receiver directly plugged into a telephone outlet (not a wireless jack) and you must subscribe to Caller ID or similar caller identification services.**

Your Caller ID enables you to:

- Identify callers before you answer the phone.
- View the time and date of each incoming call.
- Record up to 10 incoming calls sequentially.
- See who called while you were away.

There are two ways to access the Caller ID menus: by selecting *Messages* from the Main menu, or by pressing INFO on the remote control and selecting the telephone icon in the Channel Banner. The icon will be white if you have received a new call but have not accessed the Caller ID List screen. It will be gray if you have accessed the Caller ID List screen.

Setting Up Caller ID

To set up your Caller ID, go to the Main menu and select *Messages*. Then select *Caller ID Setup*. Use the up and down arrow buttons and OK button to select your preferences.

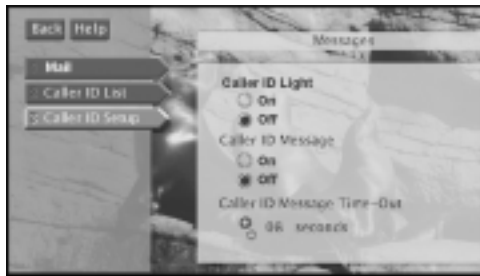

This screen allows you to set up your Caller ID.

Caller ID Light Setting *Caller ID Light* to *On* causes the front panel light to flash if you receive new calls while the digital satellite receiver is in off. The light will flash until you turn the receiver on.

Caller ID Message Setting *Caller ID Message* to *On* displays the on-screen Caller ID banner when a call is received. You may want to turn this feature off when you are recording manually and do not want the on-screen messages to appear on your recordings. Your calls will be stored in the Caller ID List screen even when Caller ID is turned off.

Caller ID Message Time-out Set the amount of time (from 1–30 seconds) that the Caller ID banner will display when you have an incoming call. For this feature to work, make sure *Caller ID Message* is set to *On*.

2 Messages

Reminder

This feature requires a subscription to a Caller ID service from your telephone company.

When you have unread Caller ID calls:

- The front panel light will flash (when the digital satellite receiver is off)
- The telephone icon in the channel banner will be highlighted white

Important

If you have a timer set to either watch or record, the Caller ID banner will be temporarily overridden for the duration of that timer. When the timer event is over, the Caller ID banner will display as selected under *Caller ID Message*.

When viewing or recording manually (not using a timer) the Caller ID banner will display (and be recorded if recording) as selected under *Caller ID Message*.

At all times Caller ID messages will be stored in the Caller ID List screen (unless a call arrives when you are on the telephone and you do not have a Type II box or Type II service).

THE MENU SYSTEM

Receiving Calls

When your phone rings twice and *Caller ID Message* is set to *On*, a banner appears at the bottom of the screen.

The banner may include the phone number, date, and time; *or* the name, phone number, date, and time. The banner information depends on the type of service your telephone company provides.



The Caller ID banner appears at the bottom of the screen when you receive a call.

The Caller ID banner will override closed captioning at the bottom of the screen and will appear for the amount of time selected in the *Caller ID Setup* screen. The call banner will not be displayed if you are in the menu system or are watching or recording with a timer and receive a call.

Message Indicators

The following is text that may appear in the incoming call banner and call list.

Out of Area The name and/or phone number of the incoming call is coming from outside the local area.

Private Name The name of the incoming call is sent as “Blocked” from the phone company.

Private Number The phone number of the incoming call is sent as “Blocked” from the phone company.

Unknown Name The name of the incoming call is not provided by the telephone company or the information is unreadable.

Unknown Number The number of the incoming call is not provided by the telephone company or the information is unreadable.

2 Messages

If you'd like more information to appear in your Caller ID banner and call list, or if you'd like to subscribe to Caller ID, check with your local phone company about the availability of different types of Caller ID service.

To clear the Caller ID banner from the screen, press CLEAR on the remote control.

THE MENU SYSTEM

The Caller ID List Screen

The digital satellite receiver can store up to 10 call entries in the Caller ID List screen. When the memory is full, a new call automatically replaces the oldest call in memory. The list also tells you if you have received multiple calls from the same number.

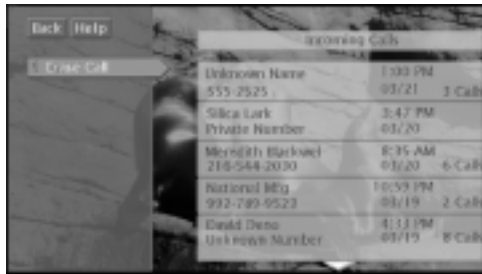

Use this screen to view the last 10 calls.

To access the call list:

- Select *Caller ID List* from the Messages menu, or
- Press the INFO button on the remote control and select the phone icon.

Deleting Calls

From the Caller ID List screen, you can delete entries:

1. Highlight the call you wish to delete and press OK.
2. A crumpled paper icon appears to indicate that you wish to delete the call.
3. To permanently delete the call, exit the screen. If you change your mind before exiting the screen, highlight the call then press OK to restore it. The crumpled paper icon should disappear.

2 Messages

Note

If you are using your telephone and another call arrives, the new call's information will neither appear in the banner nor be recorded in the Caller ID List screen unless you have type II service and a type II Caller ID box in your house.

THE MENU SYSTEM

USING THE PURCHASES MENU

The Purchases menu allows you to review upcoming and past purchases and set spending limits.

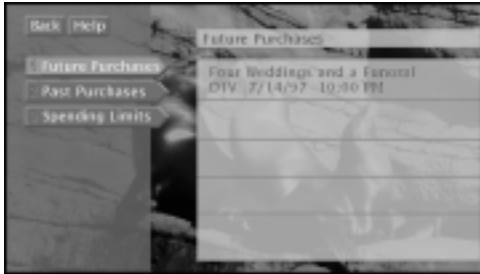

Use the Purchases menu to keep track of program purchase spending.

The list of purchases may be longer than one screen; use the up and down arrow buttons to see more items. The display also shows the title, channel, date, time, and cost of each program.

- Note that the *Past Purchases* list might show purchases for which you have already paid because the list won't be updated until the end of the billing cycle.

REVIEWING AND CANCELING AN UPCOMING PURCHASE

Use Point and Select to choose an upcoming purchase from the *Future Purchases* screen. You can review the program description, as well as cancel an upcoming purchase.

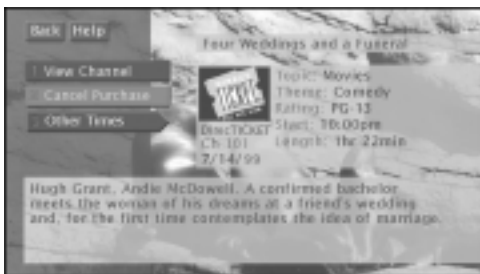

Canceling a future purchase (Program Details screen).

3 Purchases

Don't Forget About the CLEAR Button

Press the CLEAR button on the remote control to remove the on-screen menus and return to normal viewing.

THE MENU SYSTEM

PREVIEWING AND PURCHASING

You can preview and purchase DIRECTV Pay Per View movies and events if you subscribe to DIRECTV® programming and have your digital satellite receiver connected to a telephone line.

To preview a movie or event:

- When the DIRECTV program guide is on the screen, press the down arrow button on the remote control to move the highlight to the bottom of the screen. Select the *Other Guides* icon then select *Attractions*. Select a channel.

To purchase a movie or event, you can take one of two actions:

- Tune to a PPV channel by channel surfing among available channels. When you find one, press the INFO button to find more information and details about how to purchase the program.
- Highlight a PPV program in a program guide and press INFO. The Program Details screen will appear and give you more information about the program. From this screen you can also purchase the program.



The Program Details screen gives you several options.

You can select:

- *View Channel* to view that channel
- *Buy Program* to purchase the program
- *Buy and Record* to purchase the program and set a timer to record it
- *Other Times* to see what other times the program is available

The options available to you may vary according to the type of program you select.

3 Purchases



Other Guides icon

If you want to order PPV programs using the on-screen menus, you need to connect your digital satellite receiver to your telephone line.

You may need to enter your four-digit password to order a PPV program if it costs more than the spending limit you set up in the Profiles or Purchases menu.

THE MENU SYSTEM

USING THE ATTRACTIONS GUIDE

Your program providers may offer future programming events not currently listed in your program guide. These events are called “Coming Attractions,” and can be previewed in the Attractions Guide.

1. Press the GUIDE button on the remote control.
2. Use the down arrow button to move the highlight to the bottom of the screen.
3. Point to and select the *Other Guides* icon.
4. Point to and select *Attractions*.



The Other Guides menu provides several guide formats.

5. Point to a channel and select it.



The Attractions Guide is accessed through the Other Guides menu.

Purchases



Other Guides icon

THE MENU SYSTEM

TIMERS FEATURE

The Timers feature allows you to preset your digital satellite receiver to automatically tune to a particular channel at a predetermined time.

To use the Timers feature, select *Timers* from the Main menu. Select a Timer (1–8) and then use the arrow buttons to complete the on-screen sentence. When the sentence is complete, select *Run Timer*.

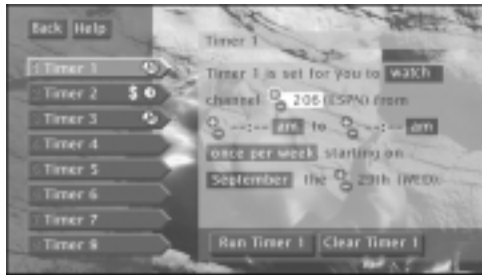

Complete the on-screen sentence to set up a timer.

Setting Up Timer Recordings

The Timers feature allows you to set up timer recordings if you have connected the VCR Controller to your digital satellite receiver and told the receiver what type of VCR you are using. See the “Setup and Connections” section for details on connecting a VCR Controller.

Editing or Canceling a Timer

From the Timers screen, select the Timer you want to edit or cancel, and then do the following:

- Use the arrows buttons to edit the Timer, then select *Run Timer*.
- Select *Clear Timer* to cancel the timer.
- To watch the program daily or weekly, edit that program’s Timer.

4 Timers

If you subscribe to Caller ID service, note that the Caller ID banner will neither be displayed or recorded during a timer (watch or record). However, all calls will be logged. The banner will display as selected when the timer recording is over.

On-screen icons are a quick way to understand the timers:



Indicates that the timer is set.



Indicates that the timer is set for a PPV.



Indicates a timer conflict.

THE MENU SYSTEM

Recording with a Timer

If you choose *Record* instead of *Watch* when setting a Timer (and have set up your VCR as previously discussed), the Timer will turn on your VCR, then start and stop recording a program.

To record with timers:

- Your VCR must be tuned to channel 3 or 4 (if the VCR is connected with just coaxial cables), or to the video input channel (if the VCR is connected with audio/video cables).
- You must turn your VCR off prior to the scheduled recording time.
- You must have a recordable tape in the VCR.

Schedule a Timer with the RECORD Button

You can schedule a recording directly from the guide.

1. With a program highlighted, press the RECORD button on the remote control. The *Program Details* screen appears.

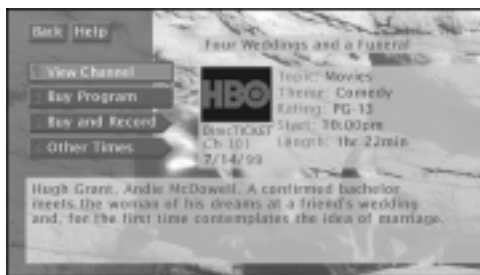

The choices available to you will differ depending on the nature of the selected program: PPV or non PPV.

2. To schedule a timer to record, select:
 - *Record Program* to set a timer to record the program, or
 - *Buy and Record* to purchase the program and set up a timer to record the program. (Programs bought to be recorded may have a different purchase price than those bought for viewing only.)

Selecting *View Channel* or *Buy Program* will tune to the program's channel without recording. The options available to you will vary according to the type of program you select.

4 Timers

THE MENU SYSTEM

PROFILES

5 Profiles

When you select *Profiles* from the Main menu, the first screen you see presents a menu of user profiles from which to choose. In addition to the Family profile, you can create as many as four different profiles that can be easily accessed using the WHO•INPUT button on the remote control.

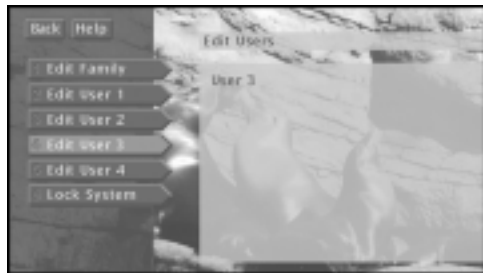

You can select one of five user profiles or lock and unlock the system.

You can also edit the user profiles. Select a profile to set a rating limit, viewing hours, and a per-event spending limit, name the profile, create a channel list, and assign a user password.

CREATING A PROFILE CHANNEL LIST

1. Point to and select a user.
2. Point to *Edit Channels* and press OK.



To start, you can add or delete all channels.

3. Use the arrow buttons to point to a channel, and press OK to remove (or replace) the check mark. Checkmarked items appear in the channel list.

THE MENU SYSTEM

Add or Delete All Channels

You might be able to save time when creating a channel list by using the *Add All Channels* option or the *Delete All Channels* option before removing or adding individual channels.

Also, program providers may make additional channels available. To prevent new channels from appearing in a profile channel list, choose *Delete All Channels* and checkmark only the channels you want to appear in the list.

5 Profiles

SETTING THE RATING LIMIT

The Rating Limit menu enables you to set a maximum rating viewing limit for rated movies (based on the MPAA rating system).

- Note that the rating limit cannot be enforced if a program has not been rated, if rating information for that program is not transmitted by the program provider, or if the system has not been locked.
1. Point to *Set Rating Limit* and press OK.

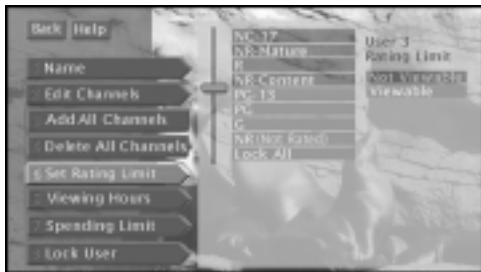

Use the arrow buttons to move the selector up and down.

2. Use the up and down arrow buttons to move the rating selector to the highest rating you want to be able to view. In the preceding illustration, movies that are rated up to and including a "PG-13" rating can be viewed.

After the Rating Limit is set and the system is locked, you must enter the system password to watch programs with a rating higher than your limit.

Important!

You need to lock the system in order for rating limits, channel limits, viewing hours, and spending limits to go into effect.

After you lock the system, you need to enter the system password to edit the limits. See "Locking the System," later in this section, for details.

THE MENU SYSTEM

VIEWING HOURS

5 Profiles

Use the *Viewing Hours* option to limit the total amount of time, as well as the time of day, that a user can watch programming.

1. Point to *Viewing Hours*, and press OK.



You can limit viewing seven days a week.

2. Use the digits on the remote control or point to the + or – buttons and press OK to complete the on-screen sentence. Choose the days to view, how many hours can be viewed each day (0–24 hours) and when programming can be viewed. Be sure to lock the system for these limits to take effect.

SETTING UP SPENDING LIMITS

Select the *Spending Limit* option to indicate a per-event spending limit for Pay Per View programs.

1. Point to *Spending Limit*, and press OK.

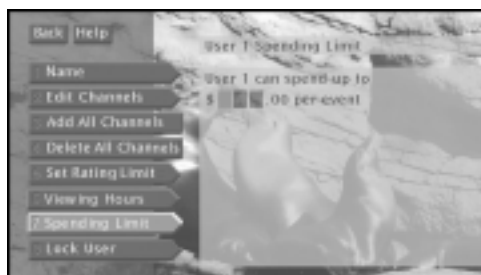

You can set a per-event spending limit for each profile.

2. Use the digits on the remote control or point to the on-screen choices and use the arrow buttons to enter a single-program spending limit.

After a Spending Limit is set and the system is locked, you must enter the system password to purchase a Pay Per View program that costs more than your Spending Limit allows.

THE MENU SYSTEM

LOCKING A USER'S PROFILE

Users can be assigned a personal password to lock their profile. When a password is assigned, users must enter the password before they can view programs using that profile. Profile passwords do not allow access to, or editing of, the profile limits. You must enter the system password to edit profile limits.

1. Point to *Lock User* and press OK.
2. Use the arrow or digit buttons to select each digit of the password.

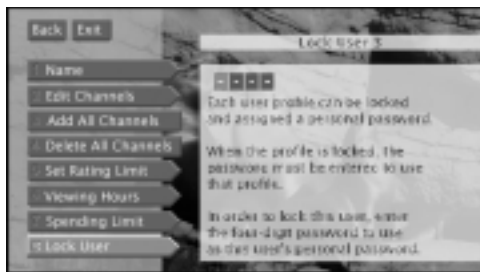

Each user can have a password.

LOCKING THE SYSTEM

Locking the system puts the ratings, spending, viewing, and channel limits you have set up for each profile into effect. When you lock the system, no one can modify any of these settings without first entering the four-digit system password.

1. Point to *Lock System* and press OK.

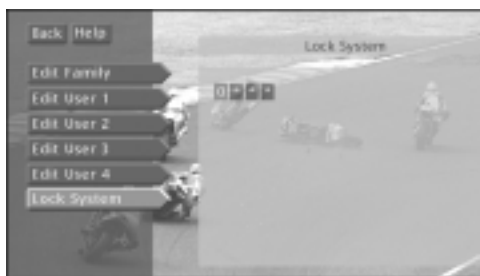

Locking the system protects the limits you set.

2. Use the arrows or the digit buttons to enter a four-digit system password.
3. Enter the password a second time to confirm it. The red lock icon should appear in the channel banner.

In order for the changes to take effect, you must exit out of the menu system.

5 Profiles

After the system has been locked, you must enter the correct password in order to access the *Edit Users* control panel.

Don't Forget Your Password

If you forget a USER password, you need to unlock the system and then assign a new user password.

If you forget the SYSTEM password, contact the DIRECTV authorization center.

THE MENU SYSTEM

Unlocking the System

When the system is unlocked, the channel, spending, viewing, and ratings limits that you set are no longer in effect. To unlock:

1. Point to *Unlock System* in the *Profiles* menu and press OK.
2. Point to *Yes* and press OK to confirm that you want to unlock the system. The green unlock icon should appear in the channel banner.

When you attempt to access a channel that is blocked by one or more limits (and the system is locked), you will be asked to override limits by entering the four-digit system password.

If you enter the password to override a limit, all limits are unlocked until you turn off the digital satellite receiver. When you turn on the receiver again, the system will be locked, and the Family profile channel list will be selected. If you want to re-lock the system without turning off the receiver, select the lock icon in the channel banner.

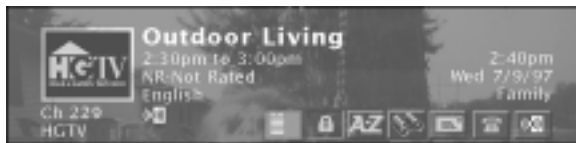

Channel banner icons are a quick way to check the current system lock status. See the note at right for more information.

Program Unlock

If the system is locked and you want to access a blocked program without unlocking all settings, press INFO and highlight the Lock icon in the channel banner. Make sure to check the box beside "Unlock this program only," and enter the system password. This program is no longer blocked, but all other settings remain in effect. The yellow unlock icon with a "P" should be displayed in the channel banner.

5 Profiles



Use the Lock and Unlock icons in the channel banner to lock or unlock the system. Just press INFO and select the icon to change the lock status.

Green Unlock icon: The system is unlocked. No limits are in effect. Spending, viewing and other limits can be accessed and changed.

Yellow Unlock icon: The system is locked, but no limits are in effect. A password has been entered to override the current profile's limits. No limits can be accessed or changed. The next time the digital satellite receiver is turned on, the system will return to *Red Lock* status.

Yellow Unlock icon with a "P": The system is locked, but no limits are in effect for the current program. A password has been entered to override the current program's limits. No limits can be accessed or changed. After the program ends, the system will return to *Red Lock* status.

Red Lock icon: All limits are in effect. No limits can be accessed or changed. A password is required to override limits or access the system.

THE MENU SYSTEM

CHOOSING YOUR PROFILE

5 Profiles

Each time you turn on the digital satellite receiver, the Family profile is selected by default. To select a different profile:

1. Press the WHO•INPUT button to scroll through the profiles.



The WHO•INPUT button toggles through the profiles.

2. When your profile appears, enter your four-digit personal password to activate your profile.
3. If the profile is not password protected, you can just press OK to activate it.

The channel, spending, rating and viewing limits associated with the chosen profile will be active only when the system is locked.

The active profile also affects what you see in the program guides. Selecting the User Preferences icon sorts the guide to show only programs meeting the current user profile criteria.



The name of the current user profile appears on screen in the Detail and Grid Guides.

Press the WHO•INPUT button on the remote control to change the current profile.

THE MENU SYSTEM

OPTIONS

The Options menu lets you set up preferences for the look and feel of the system as well as understand how some of the features work.



The Options menu lets you customize many system features.

The following sections explain your options when changing your personal preferences. Follow the on-screen instructions to make changes to the system.

INTERACTIVE SETUP

If you self-installed your satellite dish antenna, you may have already used the interactive setup to find the dish pointing coordinates, acquire and fine-tune the signal, and run a system test. If you just want to check your dish pointing coordinates or run the signal strength meter, select *Dish Pointing* from the Main menu.

SYSTEM INFO

Select *System Info* from the Options menu to choose from a list of on-line Help topics. Point and select to find out about the specific parts of the DIRECTV System.

Program Guide Shows a screen-by-screen overview of the Program Guide features.

Menu System Shows a screen-by-screen overview of the DIRECTV System menus.

Remote Control Shows a descriptive list of the remote control buttons.

Front Panel Shows a list of the digital satellite receiver's front (top) panel features. Point to an item to see a brief description.

Back Panel Shows a list of the digital satellite receiver's back panel features. Point to an item to see a brief description.

Glossary Shows a list of common DIRECTV System and TV terms. Point to a glossary item to see a brief description.

Options

THE MENU SYSTEM

LOOK AND FEEL

Default Guide Lets you choose which guide appears first when you press the GUIDE button on the remote control. The choices are Grid Guide or Detail Guide.

Color Scheme Lets you pick which colors appear in the guide and menu systems.

Translucency Lets you choose the translucency of the menu displays. Slide the indicator bar to make the screens more opaque or less opaque.

Animation Lets you select which graphics are displayed when you tune to an audio-only channel and also lets you select the animation time-out.

Edit Fetch Lets you choose a function for the FETCH button on the remote control: to either activate one feature or bring up a custom menu.

Options



Edit Fetch lets you combine your favorite features onto one menu, or assign one function to the FETCH button on the remote.

- **To create a custom Fetch menu:**
 1. Press MENU to bring up the Main menu.
 2. Point to and select *Options, Look and Feel*, and then *Edit Fetch*.
 3. Select *Fetch Control*.
 4. Select *Show Fetch Menu*.
 5. Select *Fetch List* from the Edit Fetch menu.

THE MENU SYSTEM

6. Choose up to eight menu items to include in your customized menu by checkmarking them with the OK button.



Choose which menu items to include in your customized Fetch menu.

7. Press the left arrow button to confirm your selections and return to the menu.

When you would like to access your customized menu, press the FETCH button on the remote control.

- **To assign one function to the FETCH button:**

1. Press MENU to bring up the Main menu.
2. Point to and select *Options, Look and Feel*, and then *Edit Fetch*.
3. Select *Fetch Control*.
4. Select *Assign One Function*.
5. Select *Fetch List* from the Edit Fetch menu.
6. Choose which menu item you would like to assign to the FETCH button by pointing and selecting.

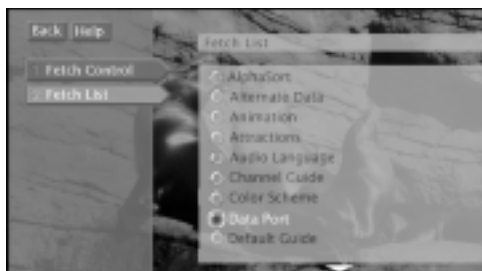

Choose which menu item to assign to the FETCH button.

7. Press the left arrow button to confirm your selection and return to the menu.

You may press the FETCH button on the remote control and execute the assigned function at any time while viewing DIRECTV® programming.

Options

THE MENU SYSTEM

SYSTEM OPTIONS

System Test The System Test screen is accessed through the Options menu and allows you to initiate diagnostic procedures on the digital satellite receiver. Use this feature to get your access card number or when your receiver doesn't seem to be working correctly. A message screen will appear to tell you whether the system passed each test.



Running the System Test is one of the choices in the System Options menu.

New Access Card Periodically, your program provider may issue you a replacement access card. The New Access Card setup display screen allows you to transfer information from the old card onto the new one.

Follow the instructions on the screen to initialize your new card. Once you have transferred the information to the new card, your old card becomes invalid. The access card fits into the digital satellite receiver through the front panel. Because your specific account information is stored in the access card, power failures should have no effect on your DIRECTV System.

Options

If your system fails a test, run the system test several times before concluding that there is a problem. Occasional fluctuations in the phone line or satellite signal can give temporary false readings.

THE MENU SYSTEM

Set VCR Type To use the One-Touch Record and Timer recording features, you need to tell the digital satellite receiver which VCR brand you are using and have your VCR Controller connected (see the “Setup and Connections” section for details).

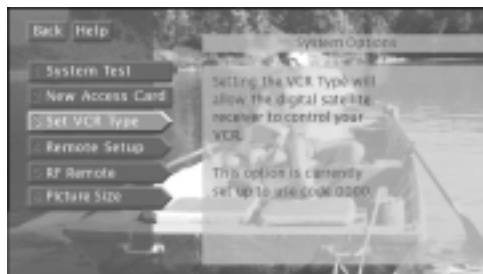

Set VCR Type is one of the choices in the System Options menu.

1. Use the up and down arrow and OK button to select the name of your VCR manufacturer and enter the correct code for your VCR brand.
2. Follow the on-screen instructions to ensure that you are using the correct code.
 - Some VCR brands may not be capable of being controlled by the digital satellite receiver.

Output Channel Lets you choose on which channel to view satellite programming, either channel 3 or channel 4.

Remote Setup Lets you choose which remote control button will be used to control the current satellite receiver.

Picture Size Lets you choose between a standard TV screen and a Cinema option. A standard TV screen has an aspect ratio of 4:3; the Cinema option has an aspect ratio of 16:9.

Options

If you do not see your VCR manufacturer's name, select *Other* (at the bottom of the list) and enter the appropriate code from the “Using the Remote” section.

THE MENU SYSTEM

AUDIO LANGUAGE

When you select *Audio Language* from the Options menu, the highlight is moved to the Audio Language display screen.

Point to the audio language or audio type you want and press OK. The digital satellite receiver will then automatically set the audio program to the selected audio program type or language, when available.



Audio Language allows you to choose the language in which you'd like to hear programming, when available.

To change the audio language:

- Select *Audio Language* on the *Options* menu and highlight the desired language. Then press OK.

Options

THE MENU SYSTEM

ALTERNATE DATA

Selects from among the available data channels.

UPGRADES

Your digital satellite receiver is able to receive upgrades or modifications to some of its features and functions. These modifications will occur automatically, usually at times when your receiver would likely be turned off. If your receiver is on when an upgrade or modification is sent, you may experience a disruption in reception for a minute or two. Your reception should return to normal after the modification is complete. Please consult the Upgrades Menu to find a schedule of upgrades or modifications planned by DIRECTV. The Upgrades feature is enhanced by *RSA™ Secure.



Future Upgrades lets you review upcoming upgrades. Past Upgrades shows you the current software version number.



The "RSA Secure" logo ensures that only authorized upgrades or modifications are delivered to your digital satellite receiver.

*RSA™ Secure and the RSA™ Secure logo are trademarks of RSA Data Security, Inc.

THE MENU SYSTEM

DISH POINTING

The Dish Pointing menu helps you set up your digital satellite receiver and optimize your reception of the satellite signal.

SELECTING DISH TYPE

It is important to complete each of the following steps required for your satellite dish antenna. If you do not, you will not receive proper dish pointing coordinates and will not be able to take full advantage of your DIRECTV PLUS™ System.

Specify the type of dish you are using:

1. Press MENU on the remote control to bring up the Main menu.
2. Use the arrow buttons on the remote control to highlight *Dish Pointing*, then press OK to access the dish pointing screen.
3. Use the arrows to highlight *Select Dish*, then press OK.
4. Specify the type of dish you are using: an oval satellite dish or a round satellite dish.

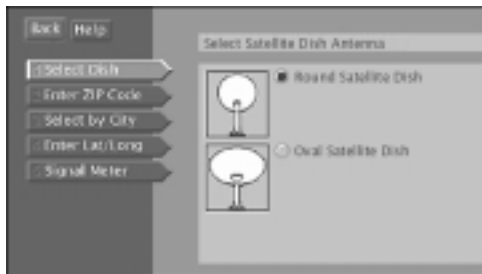

Depending on the type of satellite dish antenna you have, the Select Dish menu will prompt you for more information.

5. If you are using a round satellite dish, you are finished selecting your dish. Proceed to “Find Your Dish Pointing Coordinates,” next in this book, for further dish pointing instruction.

If you are using an oval satellite dish, you need to complete the next steps. Select the *Next* button to continue.

6. Specify the number of satellite locations from which your satellite dish antenna will be receiving signals. This number is equal to the number of LNBS (Low Noise Blockers) mounted on your dish. For example, if you have two LNBS, select *2 Satellite Location Dish*.
7. Select *Done* and proceed to “Find Your Dish Pointing Coordinates,” next in this book.

7 Dish Pointing

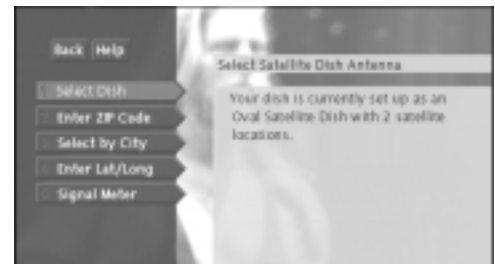

Dish Pointing shows you your the current settings for your satellite dish antenna.

It is important to select the correct dish type. If you do not, you will not receive the proper dish pointing coordinates and you will not be able to take full advantage of your DIRECTV System.

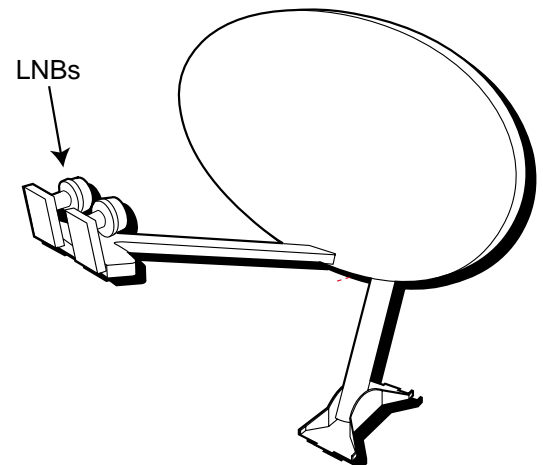

An oval satellite dish with two LNBS (not provided with all systems).

THE MENU SYSTEM

7 Dish Pointing

FIND YOUR DISH POINTING COORDINATES

If you already know your dish pointing coordinates and have placed your dish, you can proceed to the next step in this book, "Using the On-screen Signal Meter." If not, you only need to use one of the available methods (ZIP Code, City, Latitude/Longitude) to find your dish pointing coordinates.

Follow these steps to obtain your dish pointing coordinates using the ZIP Code of the dish installation location:

1. Press MENU on the remote control to bring up the Main menu.
2. Use the arrows to highlight *Dish Pointing*, then press OK to access the dish pointing screen.
3. Use the arrows on the remote control or the front panel to highlight *Enter ZIP Code*, then press OK.
4. Enter the ZIP Code for the satellite dish antenna installation location.

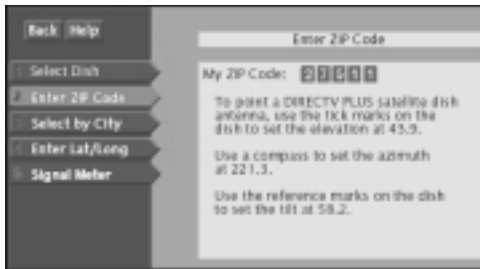

After you enter your ZIP Code, your dish pointing coordinates will appear on the screen.

5. Record the elevation, azimuth, and tilt (oval satellite dish only) numbers below.

Elevation _____ Azimuth _____

Tilt (oval satellite dish only) _____

Azimuth is the side- to-side direction that the satellite dish antenna is pointed.

Elevation is the up/down angle that the satellite dish antenna is pointed.

Tilt is the circular rotation of the dish itself, like the motion of a steering wheel.

THE MENU SYSTEM

USING THE ON-SCREEN SIGNAL METER

The signal strength meter is used to determine whether or not you are receiving the satellite signal; it also indicates the strength of the satellite signal.

Follow these steps to bring up the on-screen signal meter:

1. Press MENU on the remote control to bring up the Main menu.
2. Use the arrow buttons on the remote control to highlight *Dish Pointing*, then press OK to access the dish pointing screen.
3. Use the arrows to highlight *Signal Meter*, then press OK.

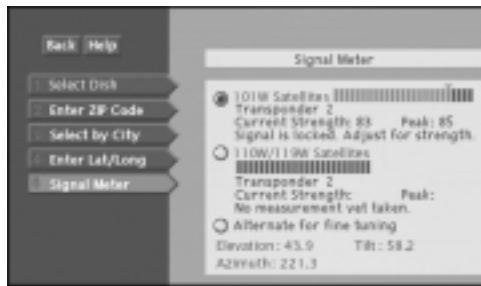

The signal meter screen you see may look somewhat different from the one pictured above.

4. Select a satellite location (such as 101W). If the satellite dish antenna is pointed correctly, the signal meter will show you the current signal strength and you should hear a continuous tone.
5. If you are using an oval satellite dish, select the second satellite group and obtain a signal.

Once you have a signal locked for both satellite locations (this may require some tweaking), you can select *Alternate for fine tuning* to improve your reception of both signals. When you select *Alternate for fine tuning*, the signal meter alternates between the two signals every four seconds. Make small adjustments to your dish's position until both signals are satisfactory.

Please see your satellite dish antenna Installer's Guide for detailed instructions.

Note

The "Peak Signal" indicates the highest signal strength you have obtained, which is not necessarily the highest possible signal (100). Although there is no difference in picture quality between signal strengths of 60 and 85, the higher the signal, the less likely you are to experience negative effects ("rain fade") in degraded conditions such as rain or snow.

Important

Changing transponders is not the same as fine-tuning the dish. Although the signal strength may change when you change transponders, this may be due to different types of signals. To fine-tune the dish, consult the Installation Guide and follow the instructions on adjusting the dish elevation, azimuth, and tilt.

TIPS & TROUBLESHOOTING

TIPS FOR SOLVING PROBLEMS

You may have some questions about using your DIRECTV PLUS™ System that you are unsure how to answer. This section provides the answers to such questions. You will find out how to access your video input channel, run a system test, and diagnose and correct problems.

1 SETUP AND CONNECTIONS



2 USING THE REMOTE



3 PROGRAM GUIDES



4 THE MENU SYSTEM



5 TIPS & TROUBLESHOOTING

TIPS & TROUBLESHOOTING

TROUBLESHOOTING

Wrong picture

The digital satellite receiver and most VCRs let you toggle between signals. If you don't see the signal you think you should be seeing, try using these buttons to toggle between the signals:

- Press the TV/VCR button on the VCR remote or on the VCR's front panel.
- Press the ANTENNA button on the remote control.

Taking either of the above actions lets you switch the source of the video signal from satellite signals to the off-air antenna or cable signal, and vice versa.

- You may not have installed your satellite dish antenna properly.

Refer to the dish pointing instructions in the Menu section of this book and the installation guide that came with your satellite dish antenna.

Problems with the remote control

- Maybe something is between the remote control and the remote sensor.
- Maybe the remote control is not in DIRECTV mode. Press the DIRECTV (or, if your remote is older, SAT1) button so the remote will control the digital satellite receiver.
- Remember to press the OK button after entering a DIRECTV channel number that is less than four digits long.
- Maybe batteries in the remote control are weak, dead or installed incorrectly. Try replacing batteries. (Note that after replacing batteries you may have to reprogram the remote to control other devices.)
- Remove batteries; press and hold the 1 button for at least 60 seconds to drain the microprocessor inside the remote control. Release number 1, replace the batteries, and (if necessary) reprogram the remote.

TIPS & TROUBLESHOOTING

Problems with Caller ID

- You can't connect your digital satellite receiver to a wireless phone jack and use the Caller ID feature. You must connect the receiver directly into a non-wireless telephone jack using a telephone cord.

Blank screen

- Maybe the component connected to the input jacks is not turned on.
- Try another channel.

Receiver will not turn on

- Check to make sure it is plugged in.
- Check the wall receptacle (or extension cord) to make sure it is "live" by plugging in something else.
- Maybe batteries in remote control are "dead."
- Maybe remote control is not aimed at remote sensor.
- Unplug the receiver. Wait five minutes. Plug it in again.

LED light flashes on front panel

- You have unread Caller ID messages or mail. Select *Messages* from the Main menu and go into either the Mail or Caller ID menu. If you select Caller ID, then select Caller ID List. Once you access your mail or messages, the flashing will stop.

Turns off while playing

- Electronic protection circuit may have been activated because of a power surge. Wait 30 seconds and then turn on again. If this happens frequently, the voltage in your house may be abnormally high or low.

TV and digital satellite receiver turn on or change channels unexpectedly

- Scheduled Watch from the Timers menu may have been activated.

VCR turns on or off unexpectedly

- A timer may be set to record. The timer will automatically turn the VCR on and off.

TIPS & TROUBLESHOOTING

FINDING THE VIDEO INPUT CHANNEL ON YOUR TV

Note: If your TV is connected with just coaxial cables, you only need to tune to channel 3 or 4.

If you used audio/video cables to connect your TV to the digital satellite receiver, you must tune your TV to the video input channel to view DIRECTV® programming and menus. There are just as many ways to access a TV's video input channel as there are brands and models of TVs. Below are some things you can try.

- If your TV brand is RCA, GE, or PROSCAN, press TV on the remote control that came with your DIRECTV System. Then press the WHO•INPUT button on the remote.
- If your TV brand is not RCA, GE, or PROSCAN, consult your TV Owner's Manual.

If you cannot find your TV Owner's Manual, you will have to investigate. You might access the TV's video input channel by:

- pressing a button on the remote control
- finding it through the TV's menu system
- tuning directly to it by pressing a specific channel number
- going through all channels in the list by pressing the channel up or down buttons on the TV

The box below lists some of the different ways manufacturers label the video input channel.

Video Input Channel Variations

Button/switch on the TV	Button on the TV Remote	Channel #
VIDEO	VID 1	00
SIGNAL	LINE	90
VID 1	VID	91
VID 2	VIDEO	92
S-VID	S-VID	VID 1
S-VIDEO	INPUT	VID 2
	SOURCE	
	AUX	

TIPS & TROUBLESHOOTING

HOW SIGNAL FLOW WORKS

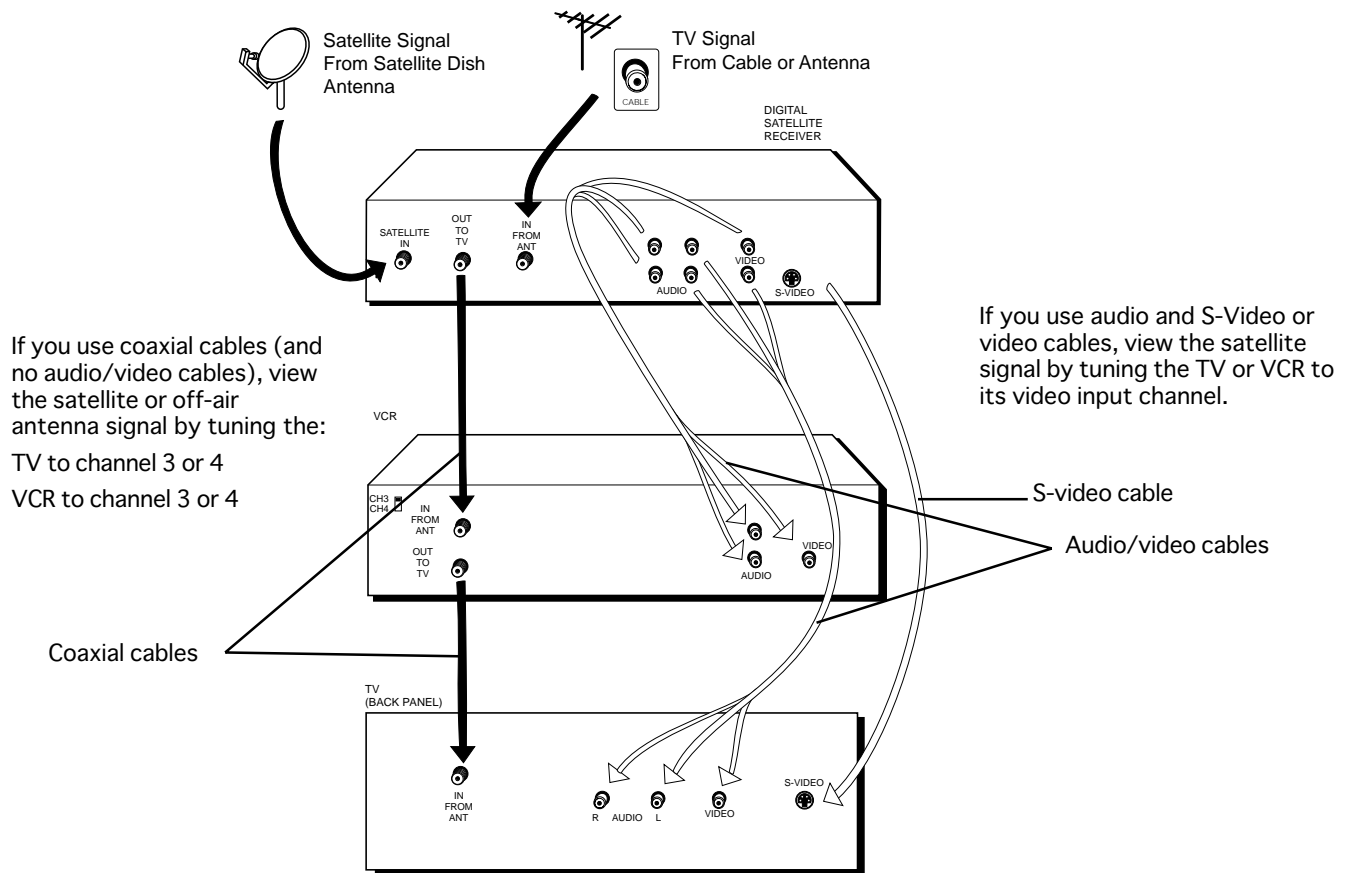

How the Satellite Signals get to Your TV

In the example above:

1. Program providers send signals to your satellite dish antenna.
2. The satellite dish antenna sends the signal to the digital satellite receiver's SATELLITE IN jack.
3. The signal continues through the coaxial or audio/video cable to the VCR and then to the TV. (The VCR may seem like an unnecessary link in the chain, but this setup lets you record DIRECTV® programming and off-air antenna/cable programming.)

If you use audio/video or S-Video cables, the satellite signal also flows through them to the TV's Video Inputs (left, right, and video or S-video).

How Off-Air Antenna/Cable Signals get to Your TV

In the example above:

1. Off-air/cable broadcasters send signals to your off-air antenna or through cable to your home.
2. The signal passes through the digital satellite receiver along the coaxial or audio/video cable to your VCR. The signal can also pass through the VCR to the TV. (The VCR may seem like an unnecessary link in the chain, but this setup lets you record DIRECTV® programming and off-air antenna/cable programming.)

TIPS & TROUBLESHOOTING

RUNNING THE SYSTEM TEST

The System Test allows you to run a basic diagnostics check on your DIRECTV PLUS™ System. If you are experiencing any trouble with your system, run the system test. It will also allow you to get your access card number or to initiate diagnostic procedures on your DIRECTV PLUS™ System.

First make sure that:

- all connections—jacks, cables, etc.—are correctly in place. See the “Setup and Connections” section for more information.
- there are batteries in the remote control, and they are working correctly.
- the access card is installed in the digital satellite receiver.

Follow these steps to run the diagnostics system test on your DIRECTV PLUS™ System.

1. Turn on your TV and the digital satellite receiver.
2. Press the DIRECTV button to put the remote control in DIRECTV mode, then press MENU to bring up the Main menu.
3. Point to and select *Options*.
4. Point to and select *System Options*.
5. Point to and select *System Test*.
6. If your system does not pass the system test, check any of these potential trouble areas: cabling, pointing the satellite dish, phone connection, and access card.
7. If you continue to have problems, call 1-800-679-4776.

You should run a system test several times before concluding that there is a problem. Occasional fluctuations in the phone line or satellite signal can give temporary false readings.

FINE-TUNING THE SIGNAL

If you self-installed your satellite dish antenna, you may have already used the interactive setup to find the dish pointing coordinates, acquire and fine-tune the signal, and run a system test.

If you need to run the interactive setup again, select *Options* from the Main menu, then select *Interactive Setup*.

If you just want to check your dish pointing coordinates, or run the signal strength meter, select *Dish Pointing* from the Main menu.

APPENDIX A: WARRANTY INFORMATION

Repair Help

Thomson Consumer Electronics offers hardware repair service if you encounter any problems with your DIRECTV PLUS™ System. Many problems can be diagnosed over the phone, or if necessary a replacement unit can be shipped to you. **Please have your DIRECTV PLUS™ System model, serial number and date of purchase ready when you call.** If your unit is out of warranty, we will quote the cost of an exchange unit to you. Refer to the Warranty for the repair service phone number.

Returning Equipment to Thomson for Repair or Exchange

If we are unable to resolve your problem over the phone we will gladly service your unit or exchange it for a new or refurbished unit. Refer to the limited warranty in this booklet to learn about your specific rights and responsibilities. *Always consult Thomson and get a Return Authorization number before returning anything.* Obtain a Return Authorization (RA) number from the telephone representative before returning your equipment to avoid delays, accounting errors, or even loss of your unit.

Important Information to Customers Who Ship Defective Equipment to Thomson Consumer Electronics

The Thomson representative who authorizes the return of your equipment will give you an RA number over the phone. The representative will also provide you with instructions on where and how to return your unit. Write the number in large, clear characters on the outside of the box. *To avoid confusion and misunderstandings, shipments without an RA number clearly visible on the outside of the box will be returned to you at your expense.* Include a brief note describing the problem and any conversations you have had with Thomson personnel about the problem. Include your name, address and model/serial number of your unit. These numbers are located on the back of your receiver. If your DIRECTV PLUS™ System is within the warranty period, please provide a copy of the bill of sale to verify purchase date. Use the original box and packing material to protect the equipment from damage in shipment. **For your protection, insure all shipments for full replacement value and use a reliable shipper.** Thomson assumes no responsibility for warranty shipments from the customer to the factory if not shipped in the manner prescribed by Thomson.

APPENDIX A: WARRANTY INFORMATION

RCA SATELLITE SYSTEM LIMITED WARRANTY

What your warranty covers:

- Any defect in materials or workmanship.

For how long after your purchase:

- 90 days - Unit exchange, which includes parts and labor.
- 91 days to 1 year - Unit exchange, which includes parts only; you pay the labor.
- The warranty for rental units begins with the first rental or 45 days from date of shipment to the rental firm, whichever comes first.

What we will do:

- **During the initial 90 days:**
Exchange the defective portion of your satellite receiver with a new or, at our option, refurbished unit.
- **After the 90 days and within one year:**
Exchange the defective portion of your satellite receiver with a new or, at our option, refurbished unit. We will charge you a flat exchange cost to replace a defective receiver. This charge covers the labor cost for its repair.

How you get service:

- Call 1-800-679-4776 and have your unit's date of purchase and model/serial number ready. The model/serial number information is on the back of your receiver.
- A representative will troubleshoot your problem over the phone.
- If the representative determines that you should receive a replacement receiver you will be provided with a Return Authorization (RA) number and the location of a nearby exchange point if one exists. No returns will be accepted without the RA number.
- If the representative determines that your antenna/dish is defective he or she will arrange for its repair or replacement.

Option 1

1. Provide your Discover, MasterCard or Visa account number and expiration date to your phone representative. This is for security purposes only and your account will not be charged at this time.
2. We will send you a replacement unit.
3. If you return the unit to us within 14 days from the date you were provided a RA number, only items not covered by warranty will be charged to your account. If your unit is not received within 14 days, the suggested retail value of the receiver will be charged to your credit card. This amount will be credited, less a \$10 handling fee, if the unit is subsequently received.
4. Ship your defective unit back to us using the replacement unit's carton. Shipping instructions will be included on the carton along with your RA number which will allow you to easily ship the unit back to us. Make sure you insure your shipment in case of damage or loss. Include with the shipment:
 - Evidence of purchase date such as a bill of sale.
 - A brief note describing your receiver problem.
 - Your name, address and phone number.

Option 2

1. We will send a replacement unit to our exchange point.
2. The exchange location will notify you of its arrival.
3. Take your unit and evidence of purchase date, such as a bill of sale, to the exchange location and you will be provided the new or refurbished unit. Please retain all accessories such as the remote control hand unit.
4. If the repairs are covered by your warranty, you will not be billed.

Thomson assumes no responsibility of warranty shipments from the customer to the factory if not shipped in the manner prescribed by Thomson.

APPENDIX A: WARRANTY INFORMATION

To receive a replacement receiver after we have received your unit:

- Write the RA number on the outside of the carton used to return the unit. Make sure you insure your shipment in case of damage or loss.
- Carefully pack the unit using the original box and packing material if possible. Please retain all accessories that were included with your unit such as the remote control hand unit.
- Include with the shipment:
 1. Evidence of purchase date such as a bill of sale.
 2. A brief note describing your receiver problem.
 3. Your name, address and phone number.
- The representative will advise the address to mail a cashier's check or money order for payment if there are any out of warranty labor or parts charges, and you elect not to use your credit card.
- After we receive your product, a new or refurbished unit will be shipped to you.

What your warranty *does not* cover:

- Acts of God, such as but not limited to lightning damage.
- Adjustment of customer controls.
- Damage from misuse or neglect.
- A unit that has been modified or incorporated into other products or is used for institutional or other commercial purposes.
- Batteries.
- Units purchased, serviced or operated outside the U.S.A. and Alaska.
- For units intended for use in Alaska, this warranty does not cover installation or the dish antenna. It only covers the satellite receiver.
- Loss of programming.
- Installation.
- Shipping damage if the unit was not packed and shipped in the manner prescribed by Thomson.
- Storage fees may be charged by the exchange point if you fail to pickup the replacement unit in a timely manner.

Product Registration:

- Please complete and mail the Product Registration Card packed with your product. It will make it easier to contact you should it ever be necessary. The return of the card is not required for warranty coverage.

How state law relates to warranty:

- This warranty gives you specific legal rights and you may have other rights that vary from state to state.

If you purchased your product outside the United States:

- This warranty does not apply. See your dealer for warranty information.

APPENDIX B: FCC REGULATIONS

FCC Registration Information

Your digital satellite receiver is registered with the Federal Communications Commission and is in compliance with parts 15B and 68, FCC Rules and Regulations.

1. Notification to the Local Telephone Company.

On the back of this equipment is a label indicating among other information, the FCC Registration number and Ringer Equivalence Number (REN) for the equipment. You must, upon request, provide this information to your telephone company.

The REN is useful to determine the number of devices you may connect to your telephone line and still have all these devices ring when your telephone number is called. In most (but not all) areas, the sum of the RENs of all devices connected to one line should not exceed 5. To be certain of the number of devices you may connect to your line as determined by the REN, you should contact your local telephone company.

Note: This equipment may not be used on coin service provided by the telephone company. Party lines are subject to state tariffs, and therefore you may not be able to use your own telephone equipment if you are on a party line. Check with your local telephone company. Notice must be given to the telephone company upon permanent disconnection of your equipment from your line.

2. Rights of the Telephone Company.

Should your equipment cause trouble on your line which may harm the telephone network, the telephone company shall, where practicable, notify you that temporary discontinuance of service may be required. Where prior notice is not practicable and the circumstances warrant such action, the telephone company may temporarily discontinue service immediately. In case of such temporary discontinuance, the telephone company must: (1) promptly notify you of such temporary discontinuance (2) afford you the opportunity to correct the situation and (3) inform you of your right to bring a complaint to the Commission pursuant to procedures set forth in Subpart E of Part 68, FCC Rules and Regulations.

The telephone company may make changes in its communications facilities, equipment, operations of procedures where such action is required in the operation of its business and not inconsistent with FCC Rules and Regulations. If these changes are expected to affect the use or performance of your telephone equipment, the telephone company must give you adequate notice, in writing, to allow you to maintain uninterrupted service.

Radio Interference

This equipment has been type tested and found to comply with the limits for a Class B Digital Device in accordance with the specifications in Part 15 of FCC Rules. These rules are designed to provide reasonable protection against radio and television interference in a residential installation. This equipment generates, uses and can radiate radio frequency energy and, if not installed and used in accordance with the instructions, may cause harmful interference to radio communications. However, there is no guarantee that interference will not occur in a particular installation.

If this equipment does cause interference to radio or television reception (which you can determine by turning the equipment off and on), try to correct the interference by one or more of the following measures.

- Reorient or relocate the receiving antenna (that is, the antenna for radio or television that is "receiving" the interference).
- Change the position of the satellite receiver with respect to the radio or television equipment that is receiving interference.
- Move the satellite receiver away from equipment receiving interference.
- Plug the satellite receiver into a different wall outlet so the receiver and equipment receiving interference are on different branch circuits.

If these measures do not eliminate interference, please consult your dealer or an experienced radio/television technician for additional suggestions. Also, the Federal Communications Commission has prepared a helpful booklet, "How To Identify and Resolve Radio/TV Interference Problems". This booklet is available from the U.S. Government Printing Office, Washington, D.C. 20402. Please specify stock number 004-000-00345-4 when ordering copies.

APPENDIX C: ACCESSORIES

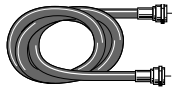

RG-6 Coaxial Burial Cable with weatherproof "F" connectors comes in a variety of lengths.

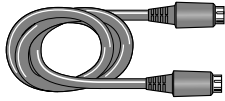

S-Video Cable comes in 12 foot lengths.

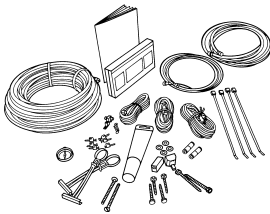

Self-Installer's Kit contains all the cable and hardware needed to install the dish and connect the system.



Remote Control replaces a lost remote. Or, order a second remote for convenience.

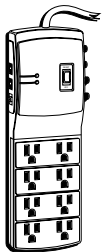

Eight outlet surge protection for cable TV, satellite systems and other electronics. Comes with a \$50,000 equipment guarantee.



Remote Controlled Rotating Outdoor/Indoor Amplified Dish Antenna features 20dB VHF and UHF signal amplification.

Accessory Order Form

Description	Part No.	Price	Qty	Total
RG-6 Coaxial Cable				
12 feet	D912	\$12.95		
25 feet	D925	\$15.95		
50 feet	D950	\$21.95		
75 feet	D975	\$24.95		
S-Video Cable 12 feet	D913	\$11.95		
Weatherproof "F" Connector (2)	D905	\$5.95		
Optical/SPDIF Cable (3-ft)	DV3	\$15.95		
Optical/SPDIF Cable (6-ft)	DV6	\$19.95		
TVRO Bullet Amplifier	D903	\$22.95		
Self-Installer's Kit	DKIT96	\$69.95		
Remote Control CRK76SG1	240968	\$34.50		
Surge Protector	SCTV160	\$49.95		
Rotating Amplified Dish Antenna	ANT2500X	\$259.95		

Total Merchandise	\$ _____
Sales Tax	\$ _____
We are required by law to collect the appropriate sales tax for each individual state, country, and locality to which the merchandise is being sent.	
Shipping, Handling, and Insurance	\$ 5.00
Total Amount Enclosed	\$ _____
Use VISA, MasterCard, or Discover preferably. Money order or check must be in U.S. currency only. No COD or CASH.	



Detach Here

All accessories are subject to availability.
Prices are subject to change without notice.

Please complete other side also

APPENDIX C: ACCESSORIES

Charge your order on your VISA, MasterCard, or Discover Card by filling in below

USE YOUR CREDIT CARD

IMPORTANT: Copy complete account number from your VISA card



My card expires:

IMPORTANT: Copy complete account number from your MasterCard



Copy Number above your name on MasterCard My card expires:

IMPORTANT: Copy complete account number from your Discover Card



My card expires:

AUTHORIZED SIGNATURE
(Credit card order will not be processed without signature)

Print or type your name and address clearly.



A complete and correct order will save you days of waiting.

Name: _____

Street: _____

_____ Apt: _____

City: _____

State: _____ Zip: _____

Daytime Phone Number: _____

Please make sure that both sides of this form have been filled out completely.

- Allow 4 weeks for delivery.
- All accessories are subject to availability.
- Prices are subject to change.

Placing an Order

To place your order by phone, have your Visa, MasterCard or Discover Card ready and call the toll-free number listed below. Use this number only to place on order for accessory items listed on this order form.

1-800-338-0376

To place your order by mail, detach and mail the completed order form with credit card information, money order or check in US currency (made payable to Thomson Consumer Electronics, Inc.) to the following address:

Video Accessories
PO Box 8419
Ronks, PA 17573

INDEX

A

Access Card
 number 14
Access card 58
Accessories 75
All button 32
AlphaSort button 25, 32
Alternate data 61
ANTENNA button 17
Arrows on remote 17
Attractions Guide 29, 46
Audio Language 60
AUX button 16
Azimuth 63

B

Binoculars Icon 25, 33
Buttons 16

C

Caller ID 40
 banner 41
 List 42
Calls, receiving 41
Cancelling purchases 43
Channel banner 25
Channel Guide 28
Channel lists 49
 add channels 50
 delete channels 50
CLEAR button 17
Codes
 remote control 20
Connections 6
 jacks and cables 5
 VCR Controller 12

D

Default Guide 56
Default guide 26
Deleting calls 42
Deleting purchases 43
Detail Guide 26
DIRECTV button 12, 16, 19, 36
Dish Pointing 62
 Coordinates 63
Dolby Digital 60
DVD button 16

E

Elevation 63
Exiting
 menus 36, 42
 program guides 28

F

Fetch 56
FETCH button 16
Front panel light 40

G

GO BACK button 16
Grid Guide 26
GUIDE button 16, 26
Guides. See Program guides

I

Icons
 24, 25, 31, 32, 33, 45, 46, 47
INFO button 16
Interactive setup 14, 55, 70

L

LED light 16. See also Front
 panel light
Lock Icons 25, 53
Locking
 a profile 52
 the system 25, 50, 52
Logo Guide 28
Look and feel 56

M

Mail
 checking 39
 deleting 39
 icon 25
Main menu 35
MENU button 17
Menu system 36
 exit 36
 help 36
 icons 47
 navigation 36
Menus 37
 Messages 39
 Options 54
 Profiles 49
 Program Guide 38
 Timers 47
Messages 39
 Caller ID 42
Movies icon 31
MUTE button 16

O

Options menu 37, 54
Other Guides
 Attractions Guide 46
 icon 28

P

Passwords 52
Pay Per View programs 45
Problems, solving 66
Profiles
 channel lists 49
 choosing 54
 locking 52
 menu 37, 49
 rating limit 50
 spending limits 51
 unlocking 54
 viewing hours 51
Program guides 23
 anatomy 24, 38
 Attractions Guide 29
 Channel Guide 28
 default 26
 Detail Guide 26
 exiting 28
 Grid Guide 26
 icons 28
 Logo Guide 28
 scrolling 26, 34
 sorting 29, 30
 tuning to a program 27
Programming
 remote control 20
Purchases 45
 cancelling 43
 menu 37, 43
 previewing 45
 reviewing 43
 spending limits 44

R

Rating limit 50
RECORD button 19, 48
Recording 11
 with timers 48
Remote control
 buttons 16
 codes 20
 modes 19
 programming 18
 setup 59
Repairs 71
Reviewing purchases 43

S

Scout 25, 33
Scrolling 26, 34
Select dish 62
Set VCR type 13
Signal meter 64

SKIP button 16
Sorting by
 All icon 32
 AlphaSort icon 32
 Movies icon 31
 Scout icon 33
 Sports icon 31
 User Preferences icon 30
Speakers 60
Spending limits 44, 51
Sports icon 31
System lock 52
System options 58
System test 70
System unlock 53

T

Telephone icon 25
Themes Icon 30
Tilt 63
Timers 47
Topics button 30
Transponders 64
Troubleshooting 66
Tuning to a program 27
TV button 16

U

Unlocking
 a profile 54
 the system 25, 53
Upgrades 61
User Preferences 30, 54

V

VCR
 button 16
 codes 21
 Controller 5, 12
 recording 17, 19, 47, 48, 59
 set type 13
Viewing call list 42
Viewing hours limit 51

W

Warranty 72
WHO•INPUT button 17

If your DIRECTV PLUS™ System needs service, please contact your dealer or the nearest Service Center from the Yellow Pages. Please do not send any products to the Indianapolis address listed in this manual or on the carton. This will only add delays in service for your product.

 **THOMSON CONSUMER ELECTRONICS**

10330 North Meridian Street
Indianapolis, IN 46290

©1999 Thomson Consumer Electronics, Inc.
Trademark(s)® Registered
Marca(s) Registrada(s)
DIRECTV and DIRECTV PLUS are trademarks of DIRECTV, Inc., a unit of Hughes Electronics Corp., and are used with permission.
Printed in USA
TOCOM 15467750



100%
RECYCLED PAPER
MINIMUM 40% POST CONSUMER

