

# RCA

## USER'S GUIDE

digitalsatellitereceiverdigitals  
atellitereceiverdigitalsatellite  
receiverdigitalsatellitereceiver  
digitalsatellitereceiverdigitals  
atellitereceiverdigitalsatellite  
receiverdigitalsatellitereceiver  
digitalsatellitereceiverdigitals  
atellitereceiverdigitalsatellite  
receiverdigitalsatellitereceiver  
digitalsatellitereceiverdigitals  
atellitereceiverdigitalsatellite  
receiverdigitalsatellitereceiver  
digitalsatellitereceiverdigitals  
atellitereceiverdigitalsatellite  
receiverdigitalsatellitereceiver  
digitalsatellitereceiverdigitals  
atellitereceiverdigitalsatellite  
receiverdigitalsatellitereceiver  
digitalsatellitereceiverdigitals  
atellitereceiver digitalsa  
tellitereceiv erdi  
gitalsatellite re  
ceiverdi gi  
talsate llit  
erecei verd  
igitalsa tell  
iterecei v  
erdigit



# Safety Information

## WARNING

To reduce risk of fire or shock hazard, do not expose this receiver to rain or moisture.

## WARNING

RISK OF ELECTRIC SHOCK  
DO NOT OPEN



This symbol indicates "dangerous voltage" inside the product that presents a risk of electric shock or personal injury.



This symbol indicates important instructions accompanying the product.

TO REDUCE THE RISK OF ELECTRIC SHOCK, DO NOT REMOVE COVER (OR BACK). NO USER SERVICEABLE PARTS INSIDE. REFER SERVICING TO QUALIFIED SERVICE PERSONNEL.

## Cautions

Do not stack electronic components or other objects on top of the digital satellite receiver. The slots on top of the digital satellite receiver must be left uncovered to allow proper airflow to the unit. Blocking the airflow to the unit could impair performance or damage your receiver and other components.

Do not stack the digital satellite receiver on top of a "hot component" such as an audio power amplifier.

FCC Regulations state that unauthorized changes or modifications to this equipment may void the user's authority to operate it.

Note to Cable TV Installer:

This reminder is provided to call your attention to Article 820-40 of the National Electrical Code (Section 54 of the Canadian Electrical Code, Part 1) which provides guidelines for proper grounding and, in particular, specifies that the cable ground shall be connected to the grounding system of the building as close to the point of cable entry as practical.

Note to Satellite Dish Installer:

This reminder is provided to call your attention to Article 810 and in particular article 810-15 of the National Electrical Code which covers proper installation and grounding of television receiving equipment as well as to article 820-40 of the National Electrical Code which specifies that the satellite dish antenna cable ground shall be connected to the grounding system of the building as close to the point of cable entry as practical.

## IMPORTANT NOTICE:

This device incorporates an anticopy process technology that is protected by U.S. patents and other intellectual property rights. The anticopy process is licensed for non-commercial, home use only. Reverse engineering or disassembly is prohibited.

Care and Cleaning:

Use a soft cloth or the dusting attachment of your vacuum cleaner to dust your digital satellite receiver. Remove dust from the ventilation holes on the top and bottom.

Plastic surfaces are easily scratched and can be marred by alcohol and various solvents. Avoid excessive use of oil-based furniture polishes since the materials used in the cabinet will accumulate more dust. A non-abrasive, anti-static cleaner/polisher is recommended.

## Product Registration

Please fill out the product registration card and return it immediately. Returning the card allows us to contact you if needed.

Keep your sales receipt to obtain warranty parts and service and for proof of purchase. Attach it here and record the serial and model numbers in case you need them. The numbers are located on the back of the player.

Model No. \_\_\_\_\_

Serial No. \_\_\_\_\_

Purchase Date: \_\_\_\_\_

Dealer/Address/Phone: \_\_\_\_\_

# Table of Contents

Setup and Connections .....	3
Step 1: Unpack the DIRECTV System .....	4
Step 2: Connect Your Digital Satellite Receiver to Your TV and VCR .....	4
Things to Know Before Connecting Components .....	4
Jacks and Cables .....	5
Back of the Digital Satellite Receiver .....	6
Basic Connection .....	7
Advanced Connection .....	8
Step 3: Find the Video Input Channel on your TV .....	9
Step 4: Interactive Setup .....	10
Step 5: Place Batteries in the Remote Control .....	10
STEP 6: Plug in and Turn on the Digital Satellite Receiver .....	10
Step 7: Order Programming .....	10
Using the Remote .....	11
Remote Control Buttons .....	12
The Point and Select Method .....	13
Programming the Remote Control .....	13
Testing the Remote control .....	13
Modes of Operation .....	14
Program Guides .....	15
Anatomy of a Program Guide .....	16
Bringing Up the Program Guides .....	16
The Channel Banner .....	17
Using the GUIDE Button .....	18
Getting Around in the Guides .....	18
Tuning to a Program .....	19
Additional Program Guides .....	20
Sorting the Guides .....	22
The Menu System .....	27
Using the Menu System .....	28
Back and Help .....	28
Menu Descriptions .....	29
The Mailbox .....	31
How to Tell When you Have Mail .....	31
Checking Your Mail .....	31
Pay-Per-View Programs .....	32
Purchasing and Previewing .....	32
Tuning to a PPV Program .....	32

# Table of Contents

Using the Attractions Guide .....	33
Using the Purchases Menu .....	34
Reviewing and Canceling an Upcoming Purchase .....	35
Spending Limits .....	35
Timers Feature .....	36
Profiles .....	36
Creating a Profile Channel List .....	37
Setting the Ratings Limit .....	37
Viewing Hours .....	38
Setting Up Spending Limits .....	39
Locking a User's Profile .....	39
Locking the System .....	40
Choosing Your Profile .....	41
Options .....	41
Look and Feel .....	42
System Options .....	43
Audio Language .....	43
Alternate Data .....	43
The Dish Pointing Menu Screen .....	44
Using the On-Screen Signal Meter .....	45
Home Control .....	46
Edit Fetch Menu .....	48
Customizing the Fetch Menu .....	49
Customizing the FETCH Button .....	50
Tips & Troubleshooting .....	51
Appendix A: Warranty Information .....	55
Appendix B: FCC Regulations .....	58
Appendix C: Accessories .....	59
Index .....	61

StarSight-Licensed: The manufacture and sale of the television schedule feature of this product was licensed under one or more of the following patents of StarSight Telecast, Inc.; U.S. Patent Nos. 4,706,121; 4,977,455; 5,151,789; 5,335,277; and 5,353,121.

# Setup and Connections

## Getting Started

This manual is designed to get you started quickly. The first three sections of the manual introduce you to your DIRECTV System and show you how to use the on-screen guides and menus.

In *Setup and Connections*, you'll learn:

- about the jacks and cables
- things to know before connecting the components
- different ways to connect the digital satellite receiver to your TV
- how to order programming

*Using the Remote* defines the buttons of the remote control and how to program it.

*Program Guides* details the items and features associated with the different guides.

## The Rest Of The Manual

The rest of the book includes menu information, troubleshooting information—such as running a system test—and an index.

**1** Setup and Connections



**2** Using the Remote



**3** Program Guides



**4** The Menu System



**5** Tips & Troubleshooting

# Setup and Connections

## Step 1: Unpack the DIRECTV System

Make sure to locate the remote control.

## Step 2: Connect Your digital satellite Receiver to Your TV and VCR

During the satellite dish antenna installation, the digital satellite receiver may have been connected to your TV with just a coaxial cable for the system test. Depending on what components you have, another connection may provide better picture and audio quality. The following sections provide cable and connection information to help you decide what connection is best for you.

### Things to Know Before Connecting Components

#### Protect Your Components from Power Surges

- Connect all components before plugging any power cords into the wall outlet.
- Always turn off the digital satellite receiver, TV and other components before you connect or disconnect any cables.

#### Position Cables Correctly to Avoid Audio Hum or Interference

- Insert all cable plugs firmly into their jacks.
- Place the audio/video cables to the sides of the TV's back panel instead of straight down the middle after you connect your components.
- Try not to coil any twin-lead cables and keep them away from the audio/video cables as much as possible.
- Make sure all antennas and cables are properly grounded. Refer to the Safety sheet packed with your unit.

# Setup and Connections

## Protect Your Components from Overheating

- Do not block ventilation holes in any of the components. Arrange the components so that air can circulate freely.
- Do not stack components.
- Allow adequate ventilation when placing your components in a stand.
- Place an amplifier or receiver on the top shelf of the stand so heated air rising from it will not flow around other components.

## Jacks and Cables

Below is a description of the jacks and cables you can use to make connections. Note that not all cables may come with your DIRECTV System.

### S-Video Jack and Cable

The S-Video jack provides the best picture quality for your DIRECTV System.

This jack is available on many TVs and is used in conjunction with audio cables to connect the digital satellite receiver to your TV. Remember to also connect the left and right audio cables because the S-Video jack carries only the picture signal, not the sound.



S-Video Jack



### RF Jacks and Coaxial Cables (F-type)

The RF jacks provide good picture and mono sound quality, and are to be used if audio/video connections are not available for your TV.

These jacks are required for antenna or cable-TV connections. The RF jacks on the digital satellite receiver are labeled IN FROM ANT and OUT TO TV.



RF Jack

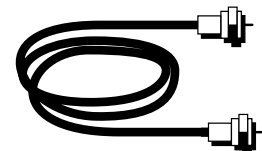

# Setup and Connections

## Back of the digital satellite Receiver

The diagram below describes each of the back panel jacks found on your digital satellite receiver. When connecting A/V cables, be sure to connect corresponding OUTPUTS and INPUTS (Video to Video, Right Audio to Right Audio, etc.).

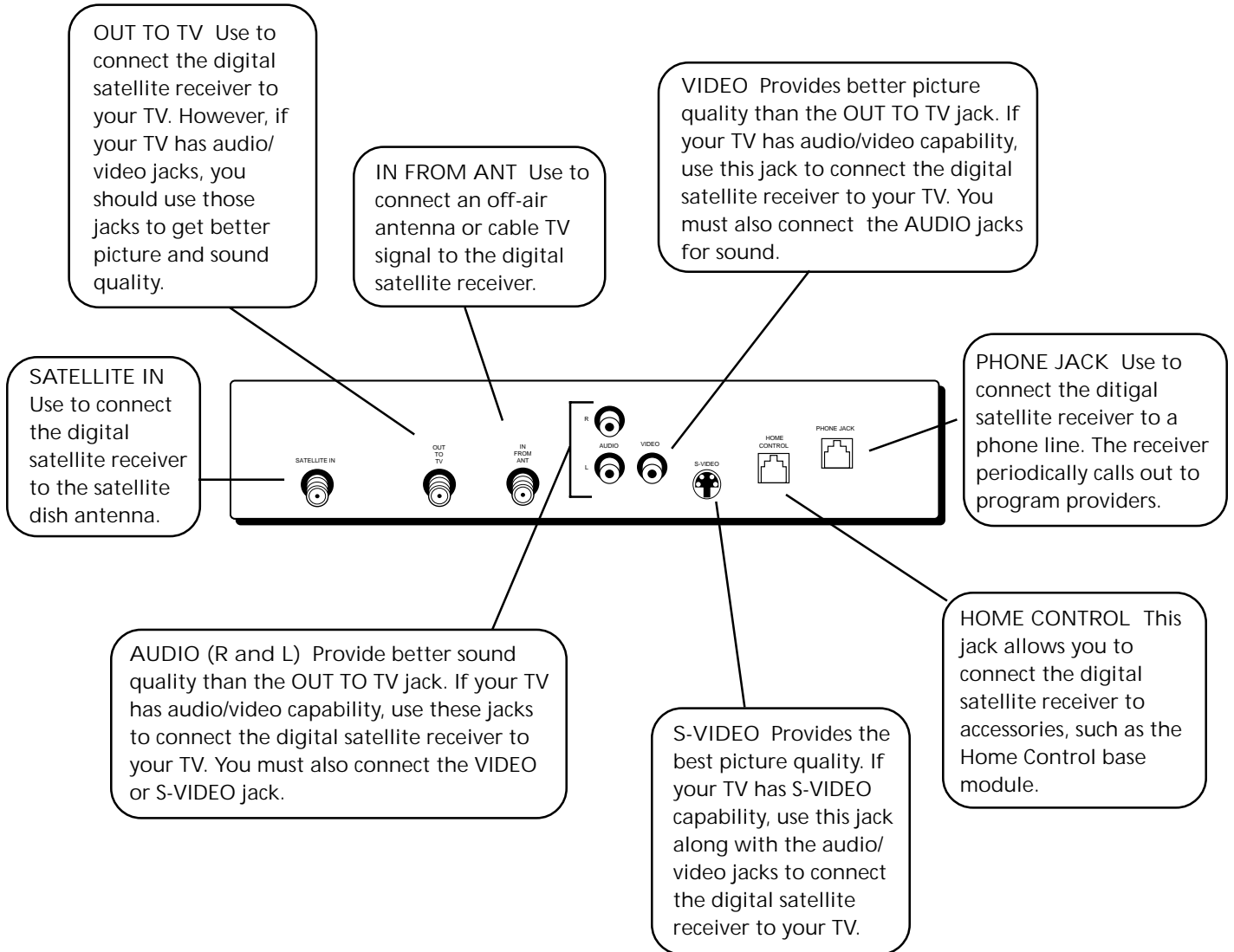



# Setup and Connections

## Basic Connection

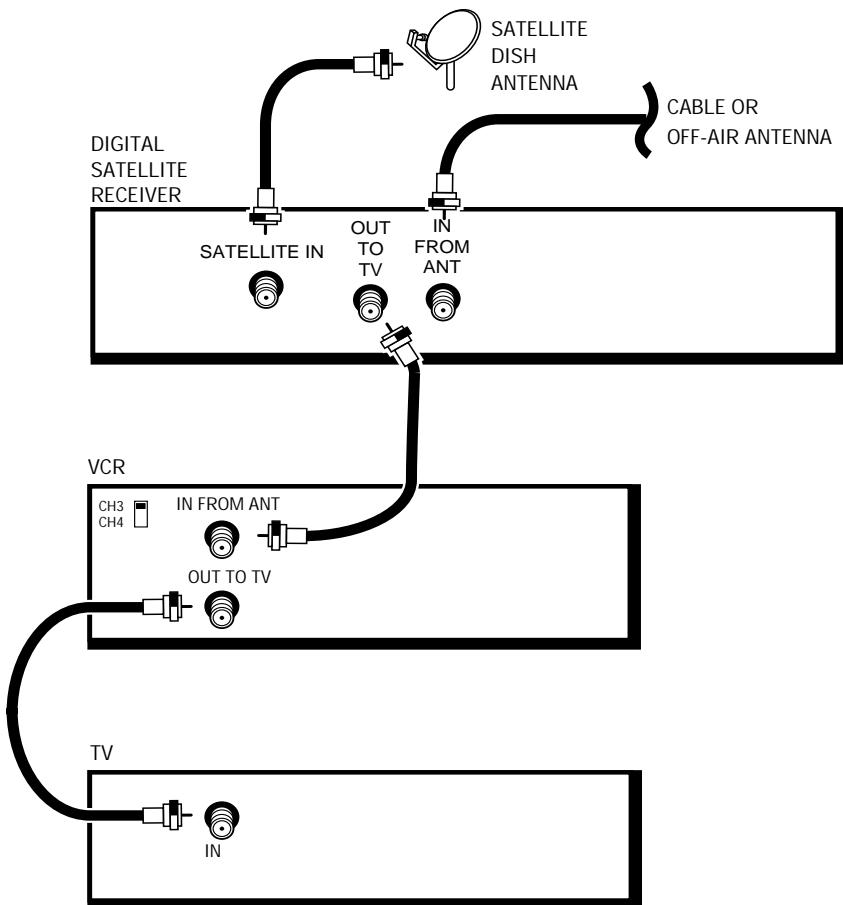

## How to View Your Components

To watch programming received via satellite with this connection, tune the TV to either channel 3 or 4. (The default is channel 3. You may change the output channel to 4 by choosing *Systems Options* from the Main menu and selecting *Output Channel*.)

To record programming, tune the digital satellite receiver to the desired channel and set your VCR to record on channel 3 or 4.

To view VCR recordings, tune the TV to the VCR output channel (usually CH 3 or 4) and set your VCR to play. If your VCR is a brand other than RCA, GE, or ProSCAN, you may need to program the remote to control the VCR. See the next section, "Programming the Remote."

### CAUTION

Do not stack electronic components or other objects on top of the digital satellite receiver. See "Safety Information" inside the front cover.

# Setup and Connections

## Advanced Connection

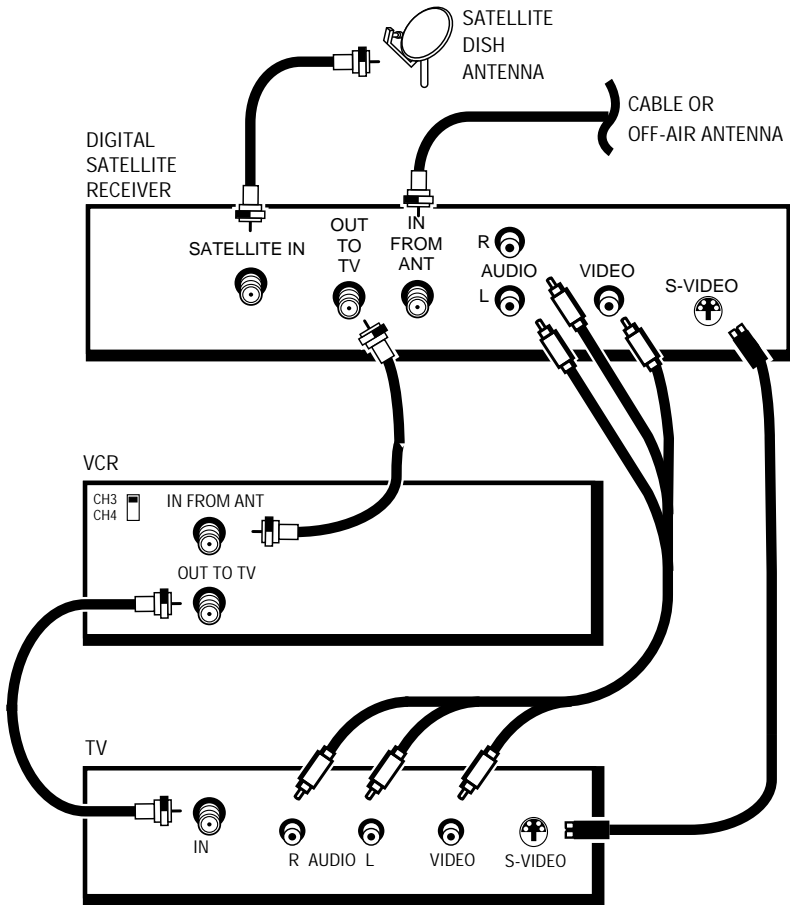

## How to View Your Components

To watch the digital satellite receiver in this connection, tune the TV to the video input channel. (To find your TV's video input channel, follow Step 3 on the next page). Then tune the receiver to the desired channel.

To record programming, tune the digital satellite receiver to the desired channel. Then set your VCR to record on channel 3 or 4.

To view VCR recordings, tune the TV to the VCR output channel (usually channel 3 or 4) and set your VCR to play. If your VCR is a brand other than RCA, GE, or ProSCAN, you may need to program the remote to control the VCR. See the next section, "Programming the Remote."

### CAUTION

Do not stack electronic components or other objects on top of the digital satellite receiver. See "Safety Information" inside the front cover.

# Setup and Connections

## Step 3: Find the Video Input Channel on your TV

Note: You do not need to complete this step if you used the basic connection.

If you used the advanced connection, you must tune your TV to the video input channel to see the satellite screens. Since there are so many brands and models of TVs, there are just as many ways to access a TV's video input channel. Below are some things you can try.

- If your TV brand is RCA, GE, or PROSCAN, press TV on the remote control that came with your digital satellite receiver. Then press the WHO•INPUT button on the remote.
- If your TV brand is not RCA, GE, or PROSCAN, consult your TV Owner's Manual.

If you cannot find your TV Owner's Manual, you will have to investigate. You might access the TV's video input channel by:

- pressing a button on the remote control
- finding it through the TV's menu system
- tuning directly to it by pressing a specific channel number
- going through all channels in the list by pressing the channel up or down buttons on the TV.

Below are lists of some of the different ways manufacturers label the video input channel.

### Video Channel Variations

Button/switch on the TV	Button on the TV Remote	Channel #
VIDEO	VID 1	00
SIGNAL	LINE	90
VID 1	VID	91
VID 2	VIDEO	92
S-VID	S-VID	VID 1
S-VIDEO	INPUT	VID 2
	SOURCE	
	AUX	

### Signal Flow

The whole idea of choosing a video input channel can be explained by the way the signal flows through your components and ends up as a picture on your TV screen.

To learn more about how signal flow works, see the example in the "Troubleshooting" section.

# Setup and Connections

## Step 4: Interactive Setup

If you self-installed your satellite dish antenna, you may have already used the interactive setup to find the dish pointing coordinates, acquire and fine-tune the signal, and run a system test.

If you need to run the interactive setup again, select *Options* from the Main menu, then select *Interactive Setup*.

If you did not self-install the satellite dish antenna, you may just want to check your dish pointing coordinates, or run the signal strength meter. Select *Dish Pointing* from the Main menu.

## Step 5: Place Batteries in the Remote Control

Follow these steps whenever you need to install or change the batteries in your digital satellite receiver's remote control.

1. Remove the cover from the battery compartment.
2. Insert batteries into the battery compartment, matching the + and – end of each battery.
3. Replace the cover.

## STEP 6: Plug in and Turn on the Digital Satellite Receiver

Plug the end into the wall outlet, matching the wide blade of the plug with the wide slot in the outlet. Be sure to insert the plug completely.

To turn on the digital satellite receiver, press the DIRECTV button on the remote control or the ON•OFF button on the front panel. If your TV brand is RCA, GE, or ProSCAN, press the TV button on the remote to turn on the TV. If your TV brand is not RCA, GE, or ProSCAN, see the next section, "Using the Remote," for details on how to use the remote to control your TV.

## Step 7: Order Programming

After you have installed your DIRECTV System, you should contact the service providers, DIRECTV or USSB, to receive programming.

Programming with DIRECTV:           Call 1-800-347-3288  
Programming with USSB:                Call 1-800-204-USSB

When you order programming, you need to know your Access Card number. To get the number, select *Options* from the Main menu, then *System Options*, and then select *System Test*.

Wait for the system to run all of its tests. The Access Card number is displayed at the end of the system test.

Write the Access Card number in the space below for easy reference:

\_\_\_\_\_

# Using the Remote

## How to use your Universal Remote control

This section defines the buttons on the remote control and describes how to program it.

The universal remote can be programmed to control most brands of remote controllable TVs. If you have an RCA, GE, or ProSCAN TV, you probably don't need to program it at all.

## 1 Setup and Connections



## 2 Using the Remote



## 3 Program Guides



## 4 The Menu System



## 5 Tips & Troubleshooting

# Using the Remote

## Remote Control Buttons

**ON•OFF** Turns the device you are controlling on or off. You can also use the power button on the top of the digital satellite receiver to turn it on and off.

**DIRECTV** Tells the remote to control the digital satellite receiver.

**TV** Tells the remote to control the TV.

**VOL UP/DOWN** Adjusts the audio volume.

**FETCH** Either brings up the Fetch menu or executes the function you assign to the button.

**CHAN UP/DOWN** Use to scan up and down through the channels in the current channel list. If you are in the program guide or menu system, use the CHAN UP/DOWN buttons to page up and down a screen at a time. You can also use the CHAN UP/DOWN buttons on the top of the digital satellite receiver to change channels.

**MUTE** Reduces the TV's volume to its minimum level. Press again to restore the volume.

**GO BACK** Moves you back and forth between your last two selected channels. In the menu system, returns you to the previous screen.

**GUIDE** Brings up the on-screen program guide. Press the GUIDE button several times to toggle through the different types of guides.

**INFO** Brings up the on-screen channel banner. Press again to get program details.

**ARROWS** Use the navigation arrows to move the on-screen highlight up, down, left, or right. Using the arrows to highlight a menu item is also called "pointing."

**OK** Selects a highlighted choice in the menu system.

**MENU** Brings up the Main menu. If you are already in the menu system, press OK or MENU to select a highlighted choice.

**CLEAR** Removes the on-screen displays and returns to normal viewing.

**DIGIT KEYS (0 - 9)** Use the digit keys to tune directly to a channel. If you are in the menu system, use the digit keys to enter numbers for the time, date, channel and passwords.

**WHO•INPUT** Press the WHO•INPUT button one or more times to toggle through your user profiles. It also accesses the line input channel.

**ANTENNA** Lets you switch the source of the video signal from satellite signals to an off-air antenna or cable signal when using the OUT TO TV jack.

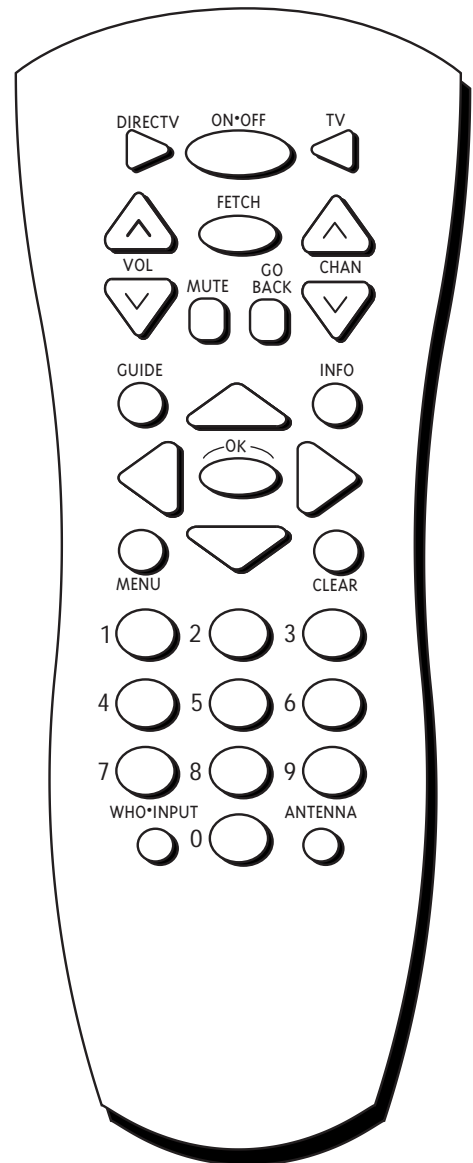

# Using the Remote

## The Point and Select Method

Point and Select is the two-step method you use to navigate through the menu system and program guides. Once you know how to point and select, you can explore the menus.

### 1. Point

You point by pressing the arrow keys on the remote control. Pressing the arrow keys moves the on-screen highlight to different items in the program guide and the menu screens. Pressing an arrow once moves the highlight one space in the direction of the arrow.

For example, to point down (that is, to move the highlight toward the bottom of the screen), press the down arrow. To point right, press the right arrow.

### 2. Select

Once you have pointed to an item on the screen, select it by pressing the OK button on the remote. Selecting an item tells the menu system to go ahead and make the change you have indicated.

For example, the instructions in the User's Manual might tell you to Point to the *Back* button and press OK.

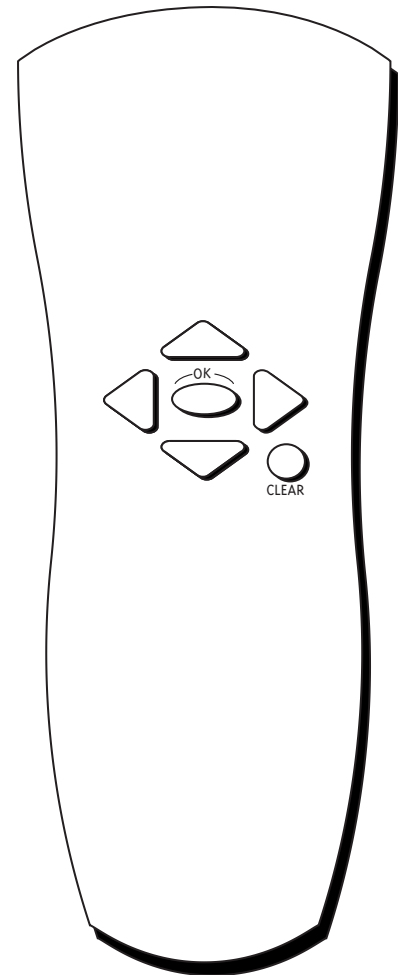

## Programming the Remote Control

The digital satellite receiver's remote can be programmed to control most brands of remote controllable TVs. The remote is programmed to control most RCA, GE and ProSCAN TVs. The remote needs to be programmed to control other manufacturers' brands.

## Testing the Remote control

To determine whether the universal remote control needs to be programmed, turn on the TV, point the remote at the TV, and press the TV button. Then press ON•OFF or CH ^ (channel up) or CH v (channel down) to see if the TV responds to the remote commands. If not, the remote needs to be programmed.

## Programming the Remote control

1. Turn on the TV.
2. Look up the brand and code number(s) for the component on the code list on the next page.
3. Press and hold the TV button.
4. Enter the code from the code list.

Don't worry about getting stuck inside a menu. Pressing the CLEAR button on the remote control takes you out of the menu system and back to the program you were watching.

This remote control may not operate all models of the brands that are shown. Use the codes shown in this manual, or on the sheet packed with your remote.

# Using the Remote

5. Release the button, and then press ON•OFF to see if the component responds to the remote control commands. If it doesn't, try pressing the component button and then ON•OFF again.
6. If you get no response, repeat these steps using the next code listed for your brand until the component responds to the remote control commands.

## Modes of Operation

Because this universal remote can control both the TV and the digital satellitereceiver, it uses operational modes triggered by the component buttons. For example if you want the remote to control the TV, you would press the TV button to put the remote into TV mode before you can control the TV.

### TV Codes

Abex .....	1172	JBL .....	1062	Radio Shack/Realistic .....	1000, 1004, 1006
Admiral .....	1001, 1173	JCB .....	1002	.....	1012, 1038, 1049, 1095, 1162, 1171, 1172
Adventura .....	1174	JC Penny 1000, 1004, 1005, 1006, 1008, 1022, 1052, 1054, .....	1058, 1063, 1064, 1072, 1087, 1105, 1128, 1171, 1172, .....	RCA .....	1000, 1003, 1004, 1005, 1006, 1007, 1019, 1096, .....
Aiko .....	1016	.....	1181	.....	1098, 1099, 1100, 1101, 1102, 1103, 1129, 1179
Akai .....	1002	Jensen .....	1004, 1006	.....	1181, 1187, 1188, 1190, 1198, 1199
Alleron .....	1046	JVC .....	1012, 1013, 1054, 1060, 1065, 1066, 1067, 1089, .....	Rhapsody .....	1176
Amtron .....	1038	.....	1157, 1158, 1159, 1182	Runco .....	1151
Anam National .....	1003, 1038	Kawasho .....	1002, 1004, 1006	Sampo .....	1004, 1006, 1171, 1172, 1175
AOC .....	1004, 1005, 1006, 1007, 1175, 1176	Kaypani .....	1175	Samsung .....	1004, 1005, 1006, 1012, 1015
Audiovox .....	1038	Kenwood .....	1004, 1006, 1019	.....	1019, 1104, 1105, 1106, 1171, 1172
Belcor .....	1004	Kloss Novabeam .....	1068, 1069, 1174, 1183	Samsux .....	1171
Bell & Howell .....	1001, 1083, 1162	KTV .....	1038, 1070, 1171, 1176, 1177	Sansui .....	1191
Bradford .....	1038	Loewe .....	1062	Sanyo .....	1004, 1048, 1049, 1050
Brokwood .....	1004	Logik .....	1083	.....	1080, 1107, 1108, 1162, 1180, 1189
Candle .....	1004, 1006, 1008, 1174	Luxman .....	1004, 1006	Scotch .....	1006
Capehart .....	1175	LXI 1000, 1006, 1049, 1062, 1071, 1072, 1073, 1162, 1181	1083	Scott .....	1004, 1006, 1012
Celebrity .....	1002	Magnavox .....	1004, 1006, 1008, 1019, 1062, 1068, 1069, .....	.....	1024, 1035, 1038, 1046
Centurion .....	1009	.....	1074, 1075, 1076, 1077, 1088, 1089, 1130, 1131, 1132, .....	Sears .....	1000, 1004, 1006, 1013, 1019, 1046, 1048, 1049, .....
Citizen .....	1004, 1006, 1008, 1016, 1038, 1105, .....	Majestic .....	1083	.....	1050, 1051, 1066, 1071, 1072, 1109, 1110, 1162, 1180, .....
.....	1171, 1174, 1177	Marants .....	1062	.....	1181, 1189
Clairtone .....	1176	Marantz .....	1004, 1006, 1062, 1078	Sharp .....	1004, 1006, 1012, 1029, 1095
Colortyme .....	1004, 1006	Megatron .....	1006, 1059	.....	1111, 1112, 1113, 1122, 1171, 1173
Concerto .....	1004, 1006	MEI .....	1176	Shogun .....	1004
Contec/Cony .....	1012, 1013, 1014, 1038, 1176	Memorex .....	1001, 1006, 1082, 1083, 1162	Signature .....	1001, 1083, 1115
Craig .....	1038	MGA .....	1004, 1005, 1006, 1019, 1022, 1051, 1079, 1080, 1082	Simpson .....	1008
Crown .....	1038, 1171	Midland .....	1054, 1151, 1171, 1172, 1181	Sonic .....	1176
Curtis Mathes ..	1000, 1004, 1006, 1015, 1105, 1162, 1171	Minutz .....	1052	Sony .....	1002
CXC .....	1038	Mitsubishi .....	1004, 1005, 1006, 1019, 1022, 1051, 1079, .....	Soundesign .....	1004, 1006, 1008, 1038, 1046
Daewoo ..	1004, 1005, 1006, 1016, 1017, 1018, 1127, 1171	.....	1080, 1081, 1082, 1083, 1125	Squareview .....	1189
Daytron .....	1004, 1006, 1171	Montgomery Ward .....	1083	SSS .....	1004, 1038
Dimensia .....	1000	Motorola .....	1003, 1173	Starlite .....	1038
Dumont .....	1004, 1151	MTC .....	1004, 1005, 1006, 1105, 1176, 1178	Supre-macy .....	1174
Dynatech .....	1178	Multitech .....	1038, 1178	Supreme .....	1002
Electroband .....	1002, 1176	Multivision .....	1084	Sylvania .....	1004, 1006, 1008
Electrohome .....	1003, 1004, 1006, 1019, 1022	NAD .....	1006, 1071, 1072, 1185	.....	1019, 1062, 1068, 1069, 1074, 1075
Emerson 1004, 1006, 1012, 1014, 1023, 1024, 1025, 1026, .....	1027, 1028, 1029, 1030, 1031, 1032, 1033, 1034, 1035, .....	NEC .....	1003, 1004, 1005, 1006, 1089	.....	1076, 1077, 1088, 1116, 1161, 1183, 1184
.....	1036, 1037, 1038, 1039, 1041, 1042, 1043, 1044, 1046, .....	Nikko .....	1006, 1016	Symphonic .....	1033, 1038, 1189
.....	1047, 1123, 1124, 1162, 1171, 1176, 1177, 1179, 1191	NTC .....	1016	Tandy .....	1173
Envision .....	1004, 1006	Onwa .....	1038	Tatung .....	1003, 1178
Fisher .....	1048, 1049, 1050, 1051, 1162, 1180	Optimus .....	1185	Technics .....	1054
Fujitso .....	1046	Optonica .....	1095, 1173	Techwood .....	1004, 1006, 1054
Funai .....	1038, 1046	Orion .....	1035, 1191	Teknika .....	1004, 1005, 1006
Futuretec .....	1038	Panasonic .....	1003, 1054, 1062, 1170	.....	1008, 1012, 1013, 1016, 1038, 1046
GE .....	1000, 1003, 1004, 1006, 1022, 1052, 1054, .....	Philco .....	1003, 1004, 1005, 1006, 1008, 1012, 1019, 1062, .....	.....	1076, 1082, 1083, 1105, 1170, 1171
.....	1055, 1087, 1164, 1165, 1166, 1167, 1168, 1181	.....	1068, 1069, 1074, 1075, 1077, 1183, 1184	Telecaption .....	1117
Gibraltar .....	1004, 1151	Philips .....	1003, 1004, 1008, 1012, 1019, 1062, 1068, 1069, .....	TMK .....	1004, 1006
Goldstar .....	1004, 1005, 1006, 1012, 1019	.....	1074, 1075, 1076, 1086, 1087, 1088, 1089	Toshiba .....	1049, 1071, 1072, 1089
.....	1056, 1057, 1058, 1155, 1156, 1171, 1172	Pilot .....	1004, 1171	.....	1105, 1109, 1117, 1118, 1160, 1162
Grundy .....	1038, 1046, 1171	Pioneer .....	1004, 1006, 1090, 1091, 1092, 1179, 1185	Totevision .....	1171
Hallmark .....	1004, 1006	Portland .....	1004, 1005, 1006, 1016, 1171	Universal .....	1052, 1087
Harvard .....	1038	Price Club .....	1105	Victor .....	1066, 1182
Hitachi ...	1004, 1006, 1012, 1013, 1059, 1060, 1061, 1135, .....	Prism .....	1054	Vidtech .....	1004, 1005, 1006
.....	1136, 1137, 1138, 1139, 1140, 1141, 1142, 1143, 1144, .....	PROSCAN .....	1000, 1181	Viking .....	1174
.....	1145, 1146, 1148, 1150, 1179	Proton .....	1004, 1006, 1012, 1093, 1175	Wards .....	1000, 1001, 1004, 1005
IMA .....	1038	Pulsar .....	1151	.....	1006, 1019, 1024, 1033, 1046, 1052
Infinity .....	1062	Pulser .....	1004	.....	1062, 1068, 1069, 1074, 1075, 1076, 1083
Janeli .....	1174	Quasar .....	1003, 1054, 1070, 1094	.....	1087, 1088, 1095, 1119, 1120, 1184
				Yamaha .....	1004, 1005, 1006, 1019
				Zenith .....	1004, 1083, 1151, 1152, 1153, 1154



# Program Guides

## What is a Program Guide?

A program guide is an on-screen programming schedule. There are several types of guides, each presenting the schedule in a different format.

Using the program guide is easy as long as you remember the Point and Select rule. Point to items on the screen by pressing the arrow keys on the remote control or front panel. Then, press OK to tune to that program.

**1** Setup and Connections



**2** Using the Remote



**3** Program Guides



**4** The Menu System



**5** Tips & Troubleshooting

# Program Guides

## Anatomy of a Program Guide

The following diagram shows you the kind of information you will see in the program guides.

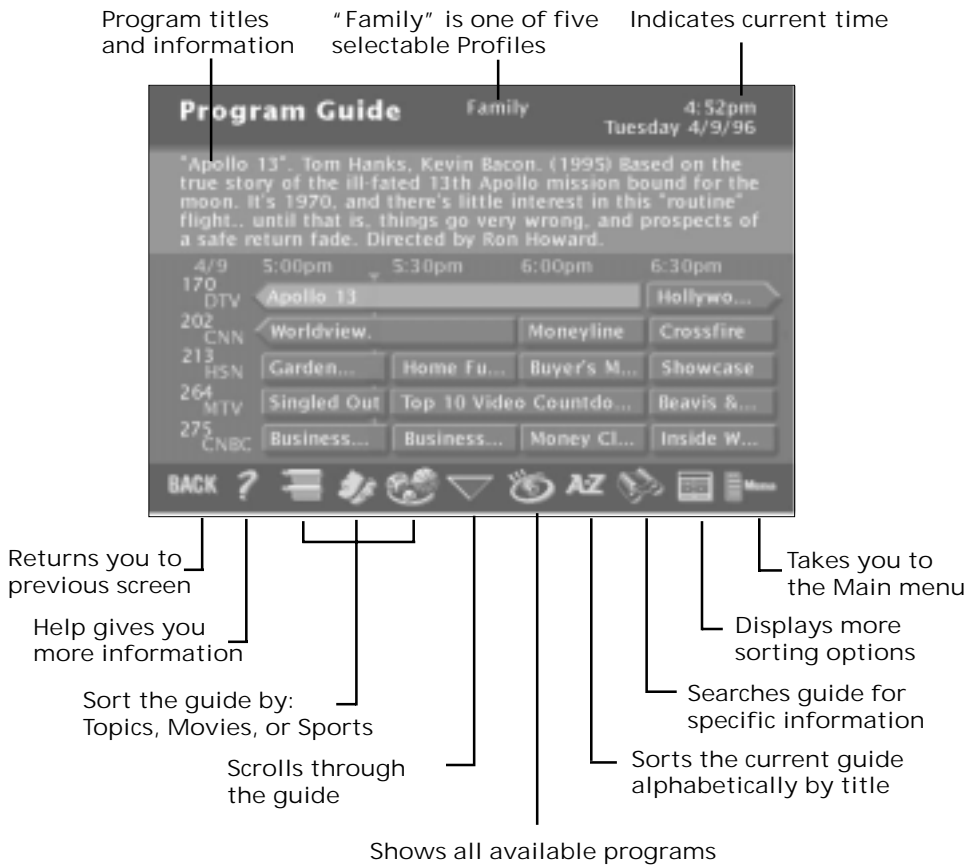

## Bringing Up the Program Guides

You can access the program guides by pressing MENU on the remote control and selecting *Program Guide*, or by using the GUIDE button on the remote.



# Program Guides

## The Channel Banner

The channel banner appears whenever you tune to a channel, exit a guide, or press INFO on the remote control. Use the arrow buttons and OK to choose an item.

On-screen icons represent frequently-used menu items. Some icons also change appearance to show the item's status. Some of the items you select in the guides can also be selected in the channel banner.

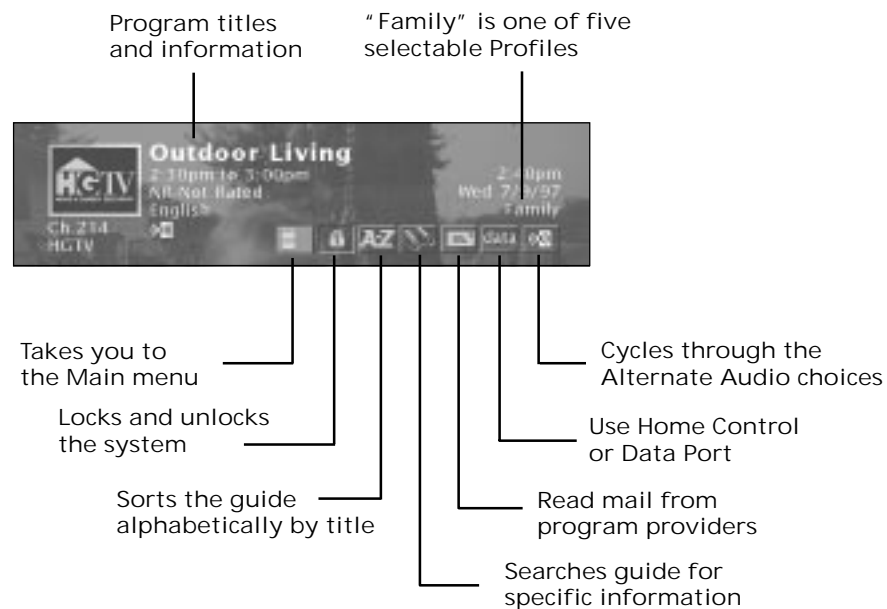

**Main menu icon** When selected, will take you to the Main menu.

**Green Unlock icon** The system is unlocked. Spending, viewing and other limits can be accessed and changed.

**Yellow Unlock icon** A password has been entered to override family or profile limits. No limits can be accessed or changed.

**Yellow Unlock icon with a "P"** A password has been entered to override limits for the current program. After the program ends, limits are restored.

**Red Lock icon** No limits can be accessed or changed. A password is required to override limits or access the system.

**AlphaSort icon** When selected, allows you to sort program titles alphabetically.

**Highlighted Scout (binoculars) icon** A Scout has found program information.

**Highlighted Mail icon** Indicates a message in your mailbox.

**Home Control or Data Port icons** The icon changes appearance depending on how the Home Control jack on the back panel is used.

**Alternate Audio icon** When selected, cycles through the alternate audio choices.

# Program Guides

## Using the GUIDE Button

Each press of the GUIDE button takes you to an alternate type of program guide.

### The Grid Guide

The Grid Guide shows seven channels in a time-and-channel format, with the full title of the highlighted program at the top of the guide.



Grid Guide

### The Detail Guide

The Detail Guide shows five channels in a time-and-channel format, with program information for the highlighted program at the top of the guide.

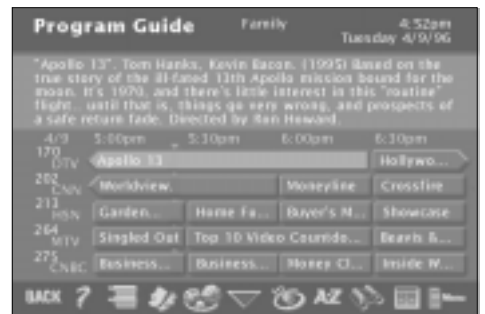

Detail Guide

### The SurfGuide

The SurfGuide displays seven channels in a half-hour time-and-channel format. Press the right arrow button to extend the SurfGuide to show the next two hours.



SurfGuide

## Getting Around in the Guides

This section describes how to change channels and move around the program guide.

### Point to Channels with the number keys (0-9)

You can point quickly to any channel in the program guide by entering the channel number with the number keys (0-9). For example, to point to channel 228, press the numbers 2-2-8 on the remote control. To point to channel 530, press 5-3-0.

### Scrolling Channel By Channel

The programs that you see on the TV screen make up one section—or page—of the total program guide. You can scroll to other sections using the arrows: point to other times with the left and right arrows; point to other channels with the up and down arrows.

### Scrolling Page By Page

If you want to scroll up or down through the program guide faster, press the CHAN UP/DOWN buttons on the remote control. The highlight scrolls a page at a time.

By default, the Detail Guide appears when you press GUIDE on the remote control. You can change the default guide from the Detail Guide to the Grid Guide or SurfGuide.

Select *Options* from the Main menu. Select *Look and Feel*, then set the *Default Guide*.

# Program Guides

## Tuning to a Program

To tune directly to a current program listed in the guide, point to the program and press OK.

To see information about a program in the guide, press INFO.



*The Program Details screen appears and gives you several options.*

Then, you can select:

- *View Channel* to tune to that channel
- *Buy Program* to purchase the program
- *Other Times* to see what other times the program is available. The program title is automatically entered and sorted in the AlphaSort control panel.

The options available to you may vary according to the type of program you select.

# Program Guides

## Additional Program Guides

Besides the Detail Guide, Grid Guide, and SurfGuide, there are a few more guides: the Channel Guide, the Logo Guide and the Attractions Guide.

You can access these guides by selecting the *Other Guides* button at the bottom of the Detail Guide and Grid Guide.



Other Guides button

## The Channel Guide

Displays a channel's programming schedule in a channel-by-channel format.

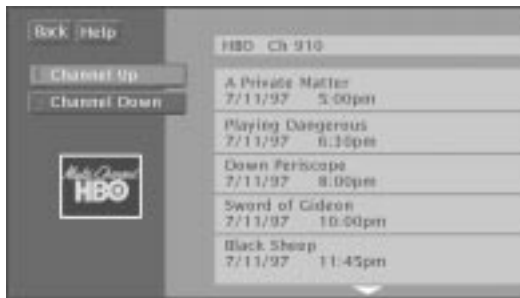

## The Logo Guide

Displays channel logos for the current user's profile.



You can point to any program then tune to that channel or get more information by pressing the OK or INFO buttons.

### Exiting A Program Guide

There are three ways to exit a guide:

- Point to a channel and press OK.
- Point to *Back* and press OK.
- Press CLEAR or GO BACK on the remote.

# Program Guides

## The Attractions Guide

Displays a list of channels that show coming attractions and special events information.

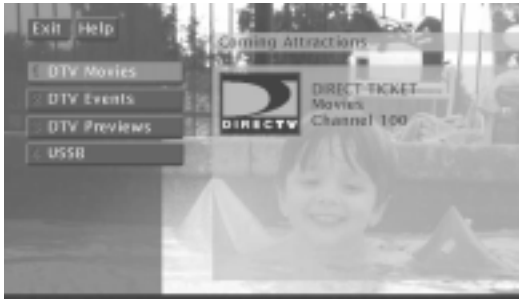

The *Other Guides* button also lets you sort the guide by different variables, such as future times, user profile channel lists, and channel groups. You can then choose a guide format to view the program information.

Select the *Other Guides* button. You can select multiple sort parameters. For example, you could sort the guide by pay-per-view movies that are available at a future time.

Select *Guide Data* and use the arrow and OK buttons to choose the *Guide Data* group.



Other Guides button

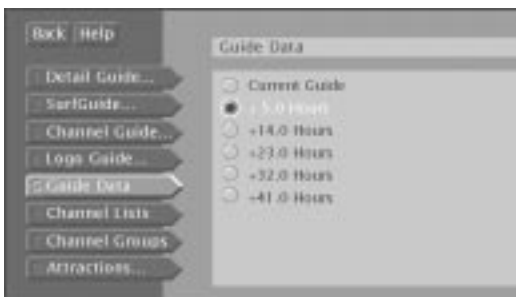

*Guide Data* lets you see what's on in the future.

# Program Guides

Then, select *PPV* in the *Channel Groups* category.



*Channel Groups* is another way to sort types of programming.

Select *Back*, or press the GO BACK button on the remote control to return to the previous guide. You can also choose another guide format from the category list.

## Sorting the Guides

Sorting the guide is a way of organizing the guide to show only the types of programs that interest you. There are several on-screen buttons that sort the guide in different ways.

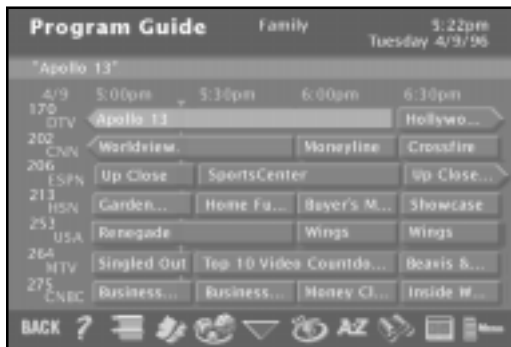

*The Sorting buttons appear at the bottom of the Grid Guide and Detail Guide.*



# Program Guides

## Topics

The *Topics* button sorts the guide according to the current user's preferences. Select the *Topics* button to sort the guide.

The *Topics* button changes to the *Topics Themes* button. Select the *Topics Themes* button to edit the current user's themes preferences. These preferences are saved in each user's profile.



Topics button



Topics Themes button



*Checkmark the themes that interest you.*

Select the categories, and checkmark the themes you would like to appear when you select the *Topics* button in the guides. Programming that fits the description of checkmarked themes will appear in the guide when you sort by the *Topics* button.

## Movies

Select the *Movies* button to list movies only. After selecting *Movies*, the *Movies* button changes to a *Movies Themes* button.

Select the *Movies Themes* button to sort the guide to list specific types of movies, such as comedies or musicals.



Movies button



Movies Themes button



*Select a Movies Themes that interests you.*

# Program Guides

## Sports

Select the *Sports* button to list sporting events only. After selecting *Sports*, the *Sports* button changes to a *Sports Themes* button.

Select the *Sports Themes* button to sort the guide to list specific types of sports, such as basketball or soccer.



Sports button



Sports Themes button



Select a Sports Theme that interests you.

## All

The *All* button resets the guide to show all available topics, channels and listings for the current Profile.



All button

## AlphaSort

*AlphaSort* lists in alphabetical order all the program titles in the current guide. Select the *AlphaSort* button to search for specific program titles that are in the current program guide. Use the arrow button to highlight a character, then press OK.

For example, to search for the program, *Auto Racing*, the first letter you should point to and select is "A". (Words like "The", "A" and "An" appear at the end of a title.) All titles that begin with "A" appear in the *AlphaSort* list. Next, enter the letter "U". All titles beginning with "AU" appear in the list.



AlphaSort button

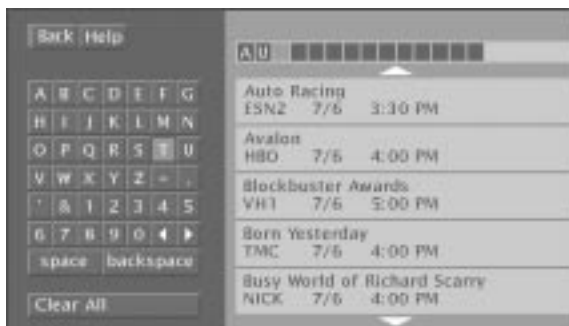

AlphaSort searches for specific titles in the guide.

# Program Guides

Continue entering the specific title's letters until it appears in the *AlphaSort* list. If you enter the wrong letter, select either *Backspace* or *Clear All*.

Use the arrow buttons to highlight the title you are looking for. Press the OK button to select it, or the INFO button to see more information. Only titles that are in the current program guide can be found by AlphaSort.

## Scout

The *Scout* button lets you assign "Scouts" to search the guide for very specific program information, such as actors' names or program descriptions. Select the Scout button from the Program Guide to view the available scouts.

Point to an available Scout, and select it. Select the *Enter Text* button to set up the information the *Scout* will look for in the program guide. Use the on-screen keyboard to enter the desired search parameters.

For example, if you are interested in National Basketball Association events, enter a common term you might see in program information, like "NBA."



Scout button

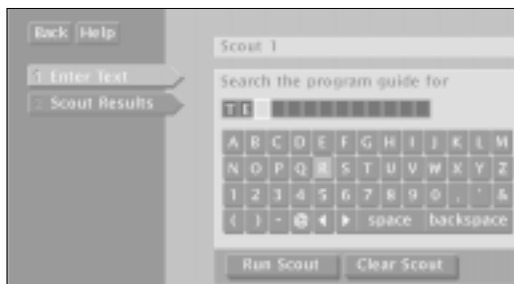

Select *Enter Text* to set up a Scout.

If "NBA" appears within a program title or program description, the program will be included in the Scout Results program list.

The Scout will search for information when the digital satellite receiver is off. (This may take up to 30 minutes for a full guide search.) You can check a Scout's results by selecting a Scout button.

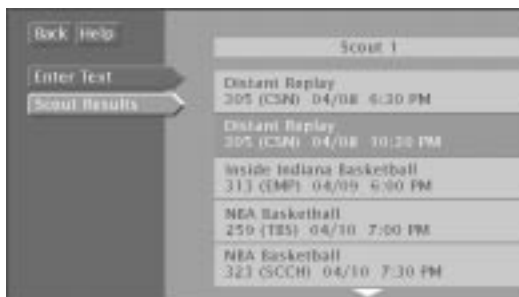

Scouts look for specific program information.

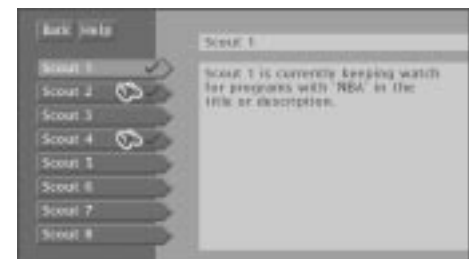

A checkmark next to the Scout means it is in use.

A highlighted binocular icon means the Scout has found something.

# Program Guides

## The Other Buttons

### Back

Exits the guide and returns you to normal viewing on the current channel. Press OK to continue.



Back button

### Help

Brings up additional information about the guide. Press OK to continue.



Help button

### Down Arrow

The arrow button allows you to scroll down through other channels in the guide. Point to the down arrow, and then press OK to scroll down through the program guide.



Arrow button

### The Main menu

Brings up the system Main menu. Press OK to continue.



Main menu button

# The Menu System

## What's a Menu?

The on-screen menu is a list of choices, just like a menu in a restaurant. And, just as a restaurant menu is divided into sections such as appetizers, entrees, and desserts, the on-screen menus are also separated into sections to help you find the information you need.

## Don't Forget Point and Select

As with all of the on-screen displays, you use Point and Select to navigate.

**1** Setup and Connections



**2** Using the Remote



**3** Program Guides



**4** The Menu System



**5** Tips & Troubleshooting

# The Menu System

## Using the Menu System

To bring up the Main menu, press MENU on the remote control.



*Use point and select to choose an item from the Main menu.*

To use the menu system, you need to know the Point and Select rule. Use the arrows on the remote control to point to an item on the screen, and then press OK to select it.

## Back and Help

There are *Back* and *Help* buttons at the top of most screens. Point to *Back* and press OK to leave that screen. Point to *Help* to see more information about that screen.

## Exiting a Screen

There are three ways to exit a menu:

- Point to *Back* and press OK.
- Press the CLEAR button on the remote control. The on-screen displays clear from the screen and you return to TV viewing.
- Press the GO BACK button on the remote control. You return to the previous on-screen display or normal programming.

## Using Help

All menus have a *Help* button. For example, selecting the *Help* button from the Main menu shows you information about using the Main menu screen.

The rest of the *Help* buttons in the menu system bring up helpful information explaining one aspect of that menu.

Use the MENU button to bring up the Main menu, and then use Point and Select to choose a menu option.

If the Main menu doesn't appear when you press MENU, the remote control might not be in satellite mode. Try pressing the DIRECTV button on the remote control, and then OK.

## Context-Sensitive Help

Most of the screens contain information to help you decide what to do next. If you get stuck, look for the help text.

# The Menu System

## Menu Descriptions

This section briefly describes each of the available Main menu options. More information about each menu and its features is included later in this chapter.

### Program Guide

Shows the on-screen programming schedules.

### Mailbox

Use to read mail messages from your program providers.

### Purchases

Use to review or cancel upcoming purchases, and to review past purchases.

### Timers

Allows you to schedule the digital satellite receiver to tune to a specific channel at a specific time.

### Profiles

Allows you to set ratings limits, spending limits, and viewing hours, as well as create favorite channel lists.

### Options

Allows you to find out more about the digital satellite receiver and remote control, change how your system looks, run the system test, and install a new access card.

### Dish Pointing

Use to find your dish pointing coordinates, and to access the on-screen signal strength meter.

### Home Control

With the proper equipment, this feature lets you control certain devices and appliances in your house.

## Don't Be Afraid to Explore

Once you've learned the basics, feel free to poke around the menu system—exploring is the best way to learn. The context-sensitive help at the bottom of the screen provides instructions for getting through any particular menu or control panel. Remember, press CLEAR at any time to leave the menu system and return to regular system viewing.

Back Help



### Don't Forget About the CLEAR Button

Press the CLEAR button on the remote control to remove the on-screen menus and return to normal viewing.

# The Menu System

## The Program Guide

Selecting *Program Guide* brings up your default program guide: the Detail Guide, the Grid Guide or SurfGuide.

1 Program Guide...

## Anatomy of a Program Guide

The following diagram shows you the kind of information you will see in the Detail Guide and Grid Guide.

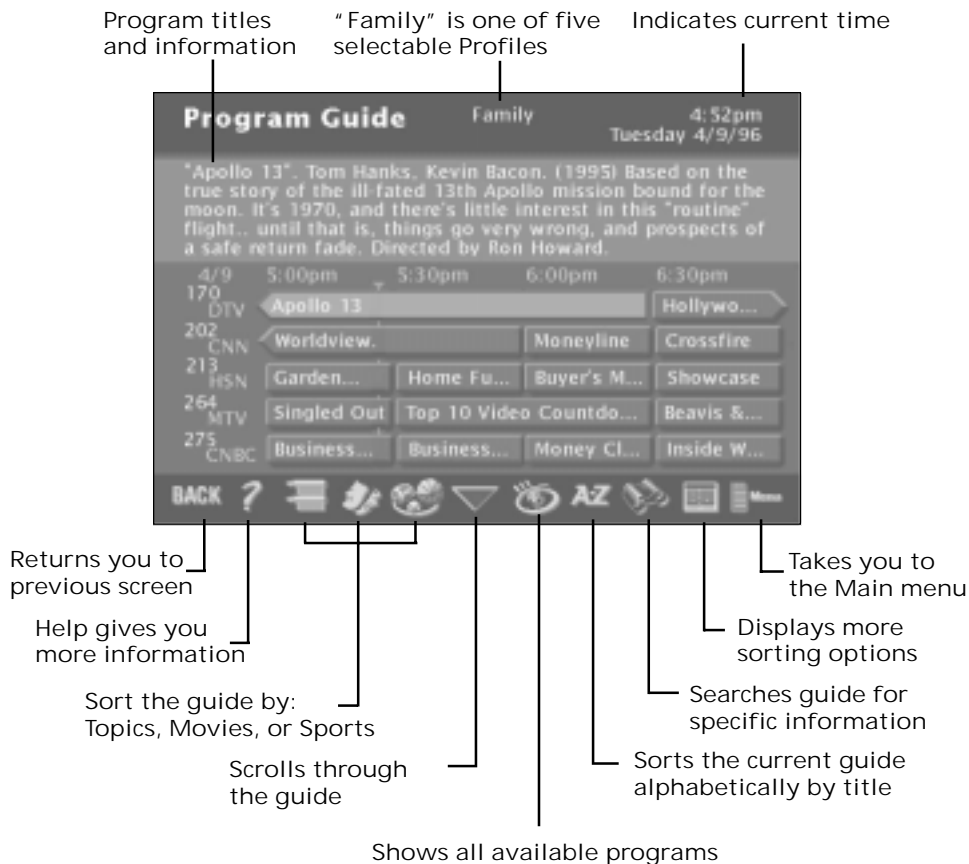

## Bringing Up the Program Guides

Besides selecting *Program Guide* in the Main menu, you can press the GUIDE button on the remote control.

### Want More Information?

Read the section in this book called Program Guides for all the details.



# The Menu System

## The Mail box

2 Mailbox...

The mailbox shows you messages that are sent—or “mailed”—from your program providers. For example, you may receive a message calling your attention to a new service.

## How to Tell When you Have Mail

There are two ways to tell if you have mail, depending on whether the digital satellite receiver is turned on or off.

- If the receiver is turned on, the mail icon in the channel banner is highlighted.
- If the receiver is turned off, the power light on the front panel of the receiver flashes.

## Checking Your Mail

Select *Mailbox* on the Main menu or channel banner to view your mail.

1. Point to a message and press OK. The message is opened for you to read.

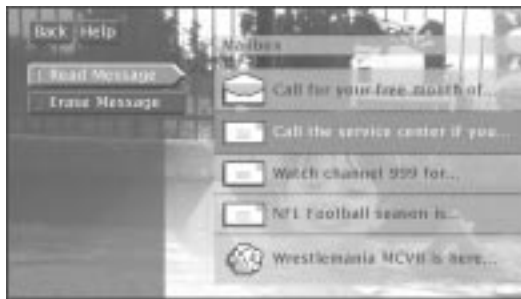

*Mail provides the latest information from program providers.*

2. Press OK again to close the letter.

After you read a message and want to erase it, point to *Erase Message* and press OK. When you exit the display screen, messages not erased are saved in memory.

# The Menu System

## Pay per view Programs

Pay per view programs (PPV) are programs that you purchase—like a movie ticket—on an event-by-event basis. For instance, a channel with Pay per view programs may run nothing but previews for movies. After previewing the movie, you can purchase it or find out more details about it. PPV programs are labeled “PPV” in the Program Guide.

## Purchasing and Previewing

There are several ways to purchase and preview PPV movies and events:

- Tune to a PPV program’s channel. Program providers may offer on-screen purchase instructions, usually as the PPV program begins.
- Choose a PPV program from the program guide.
- Preview a coming attraction by selecting a channel from the Attractions Guide.

## Tuning to a PPV Program

When you use the channel buttons or digits on the remote control to tune to a Pay per view channel, you need to press the INFO button to bring up the *Program Details* screen in order to purchase a program.



Use the program guide to get to the *Program Details* screen.

Follow the on-screen instructions to purchase the selected program.

3 Purchases...

You may need to enter your four-digit password to order a PPV program if it costs more than the spending limit you set up in the Profiles menu.

# The Menu System

## Using the Program Guide for PPV Programs

Another way to get to the Program Details screen is by using the program guide. Highlight the program name in the guide and press INFO.

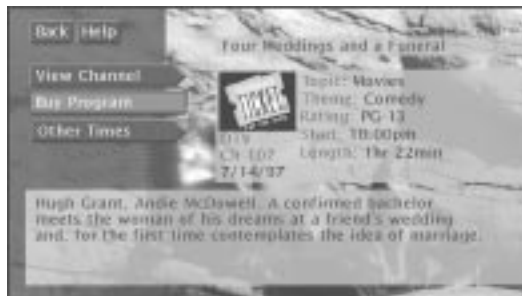

*The Program Details screen gives you several options.*

You can select:

- *View Channel* to tune to that channel
- *Buy Program* to purchase the program
- *Other Times* to see what other times the program is available. The program title is automatically entered and sorted in the AlphaSort control panel. If no other times are available, this option will not be available.

The options available to you may vary according to the type of program you select.

## Using the Attractions Guide

Your program providers may offer future programming events not currently listed in your Program guide. These events are called "coming attractions," and can be previewed in the Attractions Guide.

1. Press the GUIDE button on the remote control until the Detail Guide or Grid Guide appears on-screen.
2. Use the down arrow button to move the highlight to the bottom of the screen.
3. Point to and select the *Other Guides* button.
4. Point to and select the *Attractions Guide*.

3 Purchases...

You need to connect your phone line to your digital satellite receiver to be able to order PPV programs using the on-screen menus.

# The Menu System



The Other Guides menu provides several guide formats.

5. Point to a channel and select it.

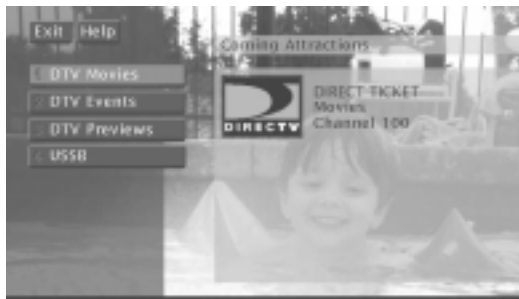

The Attractions Guide is accessed through the Other Guides menu.

## Using the Purchases Menu

The Purchases menu allows you to review upcoming and past purchases.

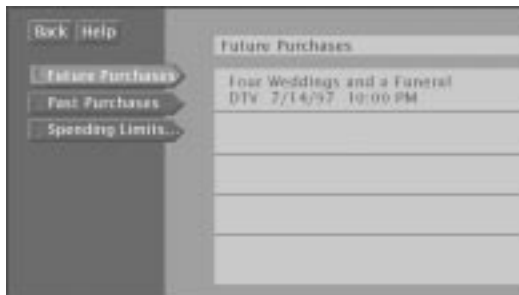

The Purchases menu shows you upcoming or past purchases, and spending limits.

The list of purchases may be longer than one screen; use the down arrow keys to see more items. The display also shows the title, channel, date, time, and cost of each program.

- Note that the Past Purchases list might be modified after each billing cycle and show purchases for which you have already paid.

3 Purchases...

# The Menu System

## Reviewing and Canceling an Upcoming Purchase

Use Point and Select to choose an upcoming purchase from the *Future Purchases* screen. You can review the program description, as well as cancel an upcoming purchase.

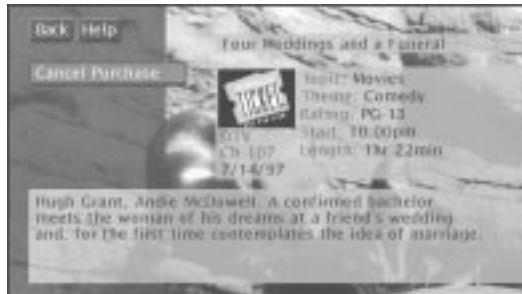

*The Purchase Edit screen lets you cancel an upcoming purchase.*

## Spending Limits

Use the *Spending Limit* option to indicate a per-event spending limit for Pay per view programs.

1. Point to *Spending Limit*, and press OK.



*You can set a per-event spending limit for each Profile.*

2. Use the digits on the remote control or use the arrow keys to enter a single-program spending limit.

After a spending limit is set *and* the system is locked, you must enter a password to purchase a Pay per view program that costs more than your spending limit allows.

## 3 Purchases...

### Important!

Spending limits are in effect only when the DIRECTV System is locked. See the section "Locking the System" for details.

# The Menu System

## Timers Feature

The Timers feature allows you to preset your digital satellite receiver to automatically tune to a particular channel at a predetermined time.

To use the Timers feature, select *Timers* from the Main menu to bring up the Timers screen. Select a Timer (1-8) and then use the arrow keys to complete the on-screen sentence. When the sentence is complete, select *Run Timer*.



Complete the on-screen sentence to set up a timer.

## Profiles

When you select *Profiles* from the Main menu, the first screen you see is the *Master Edit* control panel. In addition to the Family profile, you can create as many as four different profiles that can be easily accessed by using the WHO button on the remote control.

You can personalize the profile by entering a name.





You can personalize each profile.

You can also edit the user profiles. Select a profile from the *Edit Users* control panel. By moving down the options you can create or edit the user's channel list, set a ratings limit, viewing hours, per-event spending limits and assign a profile password.

## Timers...

On-screen icons are an easy way to understand the timers:

-  Indicates the timer is set.
-  Indicates the timer is set for a PPV.
-  Indicates a timer conflict.

### Editing or Canceling a Timer

From the Timers screen, select the Timer you want to edit or cancel, and then do the following:

- Use the arrows keys to edit the Timer, then select *Run Timer*.
- Select *Clear Timer* to cancel the timer.
- To watch the program daily or weekly, edit that program's timer.

# The Menu System

## Creating a Profile Channel List

5 Profiles...

1. Point to and select a user.
2. Point to *Edit Channels* and press OK.



To start, you can add or delete all channels.

3. Use the arrow keys to point to a channel, and press OK to remove (or replace) the check mark. Checkmarked items appear in the channel list.

## Add or Delete All Channels

You might be able to save time when creating a channel list by using the *Add All Chans* option or the *Delete All Chans* option to either add all channels or delete all channels before removing or adding individual channels.

Also, program providers may make additional channels available. To prevent new channels from appearing in a profile channel list, choose *Delete All Chans* and checkmark only the channels you want to appear in the list.

## Setting the Ratings Limit

The Ratings Limit menu enables you to set a maximum viewing limit for rated movies (based on the MPAA ratings system), as long as the program provider has transmitted the proper code.

- Note that the ratings limit cannot be enforced if a program has not been rated, if rating information for that program is not transmitted by the program provider, or if the DIRECTV System has not been locked.

# The Menu System

1. Point to *Set Rating Limit* and press OK.



Use the arrow keys to move the selector up and down.

2. Use the up and down arrows to move the rating selector to the highest rating you want to be able to view. In the preceding illustration, movies that are rated up to and including a "PG-13" rating can be viewed.

After the *Rating Limit* is set *and* the system is locked, you must enter the system password to watch programs with a rating higher than your limit.

## Viewing Hours

Use the *Viewing Hours* option to limit the total amount of time, as well as the viewing hours that a user can watch programming.

1. Point to *Viewing Hours*, and press OK.



You can limit viewing seven days a week.

2. Use the digits on the remote control or point to the + or – and press OK to complete the on-screen sentence. Choose the days to view, how many hours can be viewed each day (0-24 hours) and when programming can be viewed. Be sure to lock the system for these limits to take effect.

## 5 Profiles...

### Important!

You need to lock the system in order for rating limits, channel limits, viewing hours, and spending limits to go into effect.

After you lock the system, you need to enter the system password to edit the limits. See "Locking the System" for details.



# The Menu System

## Setting Up Spending Limits

Select the *Spending Limit* option to indicate a per-event spending limit for Pay per view programs.

1. Point to *Spending Limit*, and press OK.



You can set a per-event spending limit for each profile.

2. Use the digits on the remote or use the arrow keys to enter a single-program spending limit.

After a *Spending Limit* is set and the system is locked, you must enter the system password to purchase a Pay per view program that costs more than your *Spending Limit* allows.

## Locking a User's Profile

Each user can be assigned a personal password to lock his or her profile. When a password is assigned, the user must enter the password before he or she can view programs using that profile. Profile passwords do not allow access to, or editing of the profile limits. You must enter the system password to edit profile limits.

1. Point to *Lock User* and press OK.



Each user can have a password.

2. Use the arrow or digit keys to select each number of the password.

## 5 Profiles...

After the system has been locked, you must enter the correct password in order to access the *Edit Users* control panel.

### Don't Forget Your Password

If you forget a USER password, you need to unlock the system and then assign a new user password.

If you forget the SYSTEM password, contact your program provider's authorization center.

# The Menu System

## Locking the System

You can lock the system activate the ratings, spending, viewing, and channel limits you have set up. When you lock the system, no one can modify any of these settings without first entering the four-digit system password.

1. Point to *Lock System* and press OK.



*Locking the system protects the limits you set up.*

2. Use the arrows or the digits to enter a four-digit system password.
3. Enter the password a second time to confirm it.

For the changes to take effect, you must exit out of the menu system.

## Unlocking the System

When the system is unlocked, the channel, spending, viewing, and ratings limits that you set are no longer in effect. To unlock:

1. Point to *Unlock System* in the *Profiles* menu and press OK.
2. Point to *Yes* and press OK to confirm that you want to unlock the system.

When you attempt to access a channel that is blocked by one or more limits and the system is locked, you will be asked to unlock the system by entering the four-digit system password.

If you enter the password to override a limit, all limits are unlocked until you turn off the digital satellite receiver. When you turn on the receiver again, the system will be locked, and the Family profile channel list will be selected. If you want to re-lock the system without turning off the receiver, you can select the lock icon in the channel banner.

## Program Unlock

If the system is locked and you want to access a blocked program without unlocking all settings, press INFO and highlight the Lock icon in the channel banner. Make sure to check the box beside "Unlock this program only," and enter the system password. This program is no longer blocked, but all other settings remain in effect.

## 5 Profiles...



The Lock/Unlock icons in the channel banner provide an easy way to lock or unlock the system. Just press INFO and select the icon to change the lock status.

*Green Unlock icon* The system is unlocked. Spending, viewing and other limits can be accessed and changed.

*Yellow Unlock icon* A password has been entered to override family or profile limits. No limits can be accessed or changed.

*Yellow Unlock icon with a "P"* A password has been entered to override limits for the current program. After the program ends, limits are restored.

*Red Lock icon* No limits can be accessed or changed. A password is required to override limits or access the system.

# The Menu System

## Choosing Your Profile

5 Profiles...

Each time you turn on the digital satellite receiver, the Family profile is selected by default. To select a different Profile:

1. Press the WHO•INPUT button to scroll through the profiles.



*The WHO•INPUT button toggles through the profiles.*

2. When your profile appears, enter your four-digit personal password to activate your profile.
  - If the profile is not password protected, you can just press OK to activate it.

The channel, spending, ratings and viewing limits associated with the chosen profile will be active only when the system is locked.

## Options

The Options menu lets you set up preferences for the look and feel of the system as well as how some of the features work.



*The Options menu lets you change how the system works.*

The following sections explain your options when changing your personal preferences. Follow the on-screen instructions to make changes to the system.

# The Menu System

## Interactive Setup

If you self-installed your satellite dish antenna, you may have already used the interactive setup to find the dish pointing coordinates, acquire and fine-tune the signal, and run a system test. If you just want to check your dish pointing coordinates, or run the signal strength meter, select *Dish Pointing* from the Main menu.

A grey arrow-shaped button pointing to the right. On the left side of the arrow is a small circular icon containing a stylized 'G'. To the right of the icon, the text "Options..." is written in a light grey font.

## System Info

Select *System Info* from the *Options* menu to choose from a list of on-line Help topics. Point and select to find out about the specific parts of the DIRECTV System.

Program Guide shows a screen-by-screen overview of the Program Guide features.

Menu System shows a screen-by-screen overview of the menus.

Remote Control shows a descriptive list of the remote control buttons.

Front Panel shows a list of the digital satellite receiver's front panel features. Point to an item to see a brief description.

Back Panel shows a list of the digital satellite receiver's back panel features. Point to an item to see a brief description.

Glossary shows a list of common DIRECTV System and TV terms. Point to a glossary item to see a brief description.

## Look and Feel

Default Guide lets you choose which guide appears first when you press the GUIDE button on the remote control. The choices are Grid Guide, Detail Guide and SurfGuide.

Color Scheme lets you pick which color appears in the guides and menu system.

Translucency lets you choose the translucency of the menu displays. Slide the indicator bar to make the screens more opaque or less opaque.

Animation lets you select which graphics are displayed and also lets you select the animation time-out.

Edit Fetch lets you combine your favorite menu items onto one menu, or assign one function to the Fetch button on the remote control. (See the section, "Edit Fetch Menu" for details.)

# The Menu System

## System Options



**System Test** The System Test display screen is accessed through the *Options* menu, and allows you to initiate diagnostic procedures on the digital satellite receiver. You should use this feature to get your Access Card number, or when your digital satellite receiver doesn't seem to be working correctly.

A message screen appears, telling you whether the DIRECTV System passed each test. If your system fails a test, run the System Test several times before concluding that there is a problem. Occasional fluctuations in the phone line or satellite signal can give temporary false readings.

**New Access Card** Periodically, your program provider may issue you a replacement Access Card. The New Access Card Setup display screen allows you to transfer the information from the old card onto the new one. The Access Card fits into the receiver through the front panel.

Follow the display screen prompts to initialize your new card. Once you have transferred the information to the new card, your old card becomes invalid.

Because your specific account information is stored in the access card, power failures should have no effect on your DIRECTV System.

**Remote Setup** Lets you choose which remote button will control the digital satellite receiver if you are using a universal remote that did not come with the DIRECTV System.

**Output Channel** Lets you choose on which channel to view satellite programming, either channel 3 or channel 4.

**Picture Size** The Picture size display screen allows you to choose between a standard TV screen and a Cinema option. A standard TV screen has an aspect ratio of 4:3; the Cinema option has an aspect ratio of 16:9.

**Data Port** Lets you choose whether the low speed data port is used for low speed data or communicating with the Home Control Base accessory. See the Home Control section in this book for more information.

## Audio Language

When you select *Audio Language* from the *Options* menu, the Audio Language display screen comes up.

Point to the audio language or audio type you want and press OK. The digital satellite receiver audio will then automatically be set to the selected language (when the language is available).

## Alternate Data

Selects from among the available data on the current channel.

# The Menu System

## The Dish Pointing Menu Screen

## 7 Dish Pointing...

Follow these steps to obtain your satellite dish antenna pointing coordinates:

1. Turn on your television and digital satellite receiver.
2. Tune your television to the digital satellite receiver's output channel.
3. Press MENU on the remote control to bring up the Main menu.
4. Use the arrows to highlight *Dish Pointing*, and then press OK to access the dish pointing screen.

*NOTE: The menu screen that you see may be slightly different from the one pictured here.*



5. Use the arrows on the remote control or the front panel to highlight *Zip Code*, and then press OK.
6. Enter the zip code for the satellite dish antenna installation location.
7. Record the elevation and azimuth numbers below.

Elevation \_\_\_\_\_ Azimuth \_\_\_\_\_

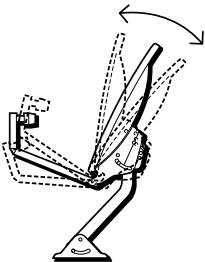

*Elevation is the up/down angle that the satellite dish antenna is pointed.*

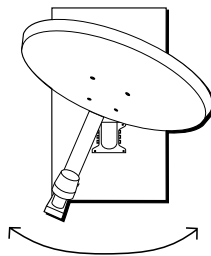

*Azimuth is the side-to-side direction that the satellite dish antenna is pointed.*

You only need to use one of the available methods to find your satellite dish antenna pointing coordinates. If you know the zip code for the satellite dish antenna location, use that.

# The Menu System

## Using the On-Screen Signal Meter

The signal strength meter is used to determine whether or not you are receiving the satellite signal; it also indicates the strength of the satellite signal.

Follow these steps to bring up the on-screen signal meter:

1. Turn on your television and digital satellite receiver.
2. Tune your television to the digital satellite receiver's output channel.
3. Press MENU on the remote control to bring up the Main menu.
4. Use the arrows to highlight *Dish Pointing*, and then press OK to access the dish pointing screen.
5. Use the arrows on the remote control to highlight *Signal Meter* and then press OK.

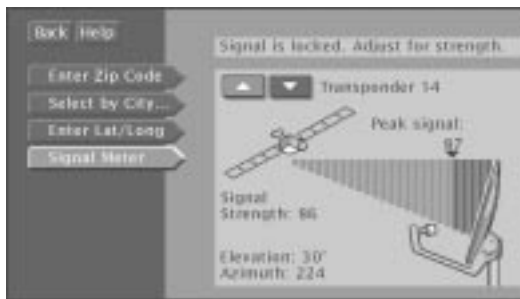

*If the satellite dish antenna is pointed to the correct azimuth and elevation, the signal meter will show you the current signal strength (and you should hear a continuous tone).*

If you are not receiving a signal, you need to incrementally adjust the azimuth setting on the satellite dish antenna. After you receive a signal, you will want to continue to adjust the azimuth to try to get the best possible signal.

### Important

Changing transponders is not the same as fine-tuning the satellite dish antenna. Although the signal strength may appear to change, this may be due to different types of interference. To fine-tune the satellite dish antenna, consult the Installation Guide and follow the instructions on adjusting the satellite dish antenna's elevation and azimuth.

## 7 Dish Pointing...

### Peak Signal

The "Peak Signal" indicates the highest signal strength you have obtained, which is not necessarily the highest possible signal.

While the maximum signal strength is 100, the signal strength you achieve will probably be less. Although there is no difference in picture quality between signal strengths of 60 and 85, the higher the signal, the less likely you are to experience negative effects in degraded conditions such as rain or snow (called "rain fade").

# The Menu System

## Home Control

Home Control lets you remotely control several lamps and devices through your digital satellite receiver.

### Home Control Setup

The Home Control Data Interface connects to the HOME CONTROL jack on the back of the digital satellite receiver. Once connected, you must tell the receiver to use this port for Home Control.

1. Press OK to bring up the Main menu.
2. Point to and select *Options*.
3. Point to and select *System Options*.
4. Point to and select *Data Port* and choose *Home Control* as the default setting.

### Device Setup

1. From the Main menu select *Home Control*.



*Home Control can control several devices.*

2. Select a device you would like to control.
3. Complete the on-screen sentence using the arrow buttons and OK. Press OK to scroll through the lists of devices and locations.

## Home Control...

To use the home control feature, you must connect one end of the Home Control Data Interface to a remote module attached to the appliance you want to control. The other end should connect to the HOME CONTROL jack on the back of the digital satellite receiver via a coiled telephone handset cord (available from most retailers).

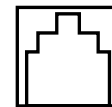

Home Control Jack on the Back Panel

Home control modules are available as accessories sold through your satellite dealer or the accessories order form at the back of this book.



# The Menu System

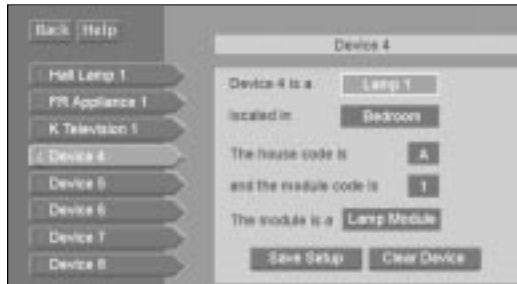

Keep track of devices by assigning a label.

4. Use the arrow buttons and OK to select the house and module codes that match the device's remote module and label the module. Select *Save Setup* to complete the setup.

## Device Control

Once the device is set up, there are two ways to control it: with the menu system or with a timer. Select a device from the Home Control menu screen. You can then turn it on, turn it off, or adjust the brightness for lamp modules.

Select *Edit Setup* to change a device.



Control the device from the menu.

To schedule a timer:

1. Select *Set Timer*.
2. Schedule a timer by completing the on-screen sentence.

8 Home Control...

On-screen icons are an easy way to understand the timers:



Indicates the timer is set.



Indicates the timer is suspended.

You can schedule several timers to control the same device at different times.

# The Menu System



Complete the on-screen sentence to schedule a timer.

3. Use the arrows and OK to enter an *on* and *off* time.
4. Point to and select *Run Timer*.

*Clear Timer* removes all the timer information.

*Suspend* turns off the timer, but saves the timer information.

## Edit Fetch Menu

The Edit Fetch menu gives you the option of using Fetch in two ways:

- You can customize eight functions on the Fetch menu, or
- You can customize the Fetch button on the remote control to take a certain action each time it is pressed.

To view the Edit Fetch Menu, press MENU to bring up the Main menu, select *Options*, select *Look and Feel*, and then select *Edit Fetch*.



The Edit Fetch menu is a convenient way to call up frequently used menu items.

# The Menu System

## Customizing the Fetch Menu

To customize your Fetch menu:

1. Press MENU to bring up the Main menu.
2. Point to and select *Options, Look and Feel*, and then *Edit Fetch*.
3. Select *Fetch Control*.
4. Press OK to choose *Show Fetch Menu*.
5. Select *Fetch List* from the Edit Fetch menu.
6. Choose which eight menu items you would like to include in your customized menu by checkmarking them with the OK key.



*Choose which menu items to include in your customized Fetch menu.*

7. Press the left arrow key to confirm your selections and return to the menu.

When you would like to access your customized menu, press the FETCH button on the remote control.

# The Menu System

## Customizing the FETCH Button

To customize the FETCH button on the remote control:

1. Press MENU to bring up the Main menu.
2. Point to and select *Options, Look and Feel*, and then *Edit Fetch*.
3. Select *Fetch Control*.
4. Choose *Assign One Function*.
5. Select *Fetch List* from the Edit Fetch menu.
6. Choose which menu item you would like to assign to the FETCH button by pointing and selecting.



*Choose which menu item to assign to the FETCH button.*

7. Press the left arrow key to confirm your selection and return to the menu.

You may press the FETCH button on the remote control and execute the assigned function at any time while viewing satellite programming.

# Tips & Troubleshooting

## Tips for Solving Problems

You may have some questions about using your DIRECTV System that you are unsure how to answer. This section provides the answers to such questions. You will find how to run a system test, and how to diagnose and correct problems.

**1** Setup and Connections



**2** Using the Remote



**3** Program Guides



**4** The Menu System



**5** Tips & Troubleshooting

# Tips & Troubleshooting

## Running the System Test

The System Test allows you to run a basic diagnostics check on your DIRECTV System. If you are experiencing any trouble with your system, run the system test. It will allow you to get your Access Card number, or to initiate diagnostic procedures on the system.

First make sure that:

- All connections—jacks, cables, etc.—are correctly in place. See the section “Setup and Connections” for more information.
- There are batteries in the remote control, and they are working correctly.
- The Access Card is installed in the digital satellite receiver.

Follow these steps to run the system test:

1. Turn on your TV and the digital satellite receiver.
2. Press the DIRECTV button on the remote control to put it in satellite system mode, then press MENU to bring up the Main menu.
3. Point to and select *Options*.
4. Point to and select *System Options*.
5. Point to and select *System Test*.
6. If your system does not pass the system test, check these potential trouble areas: cabling, pointing the satellite dish, phone connection, and access card.
7. If you continue to have problems, call 1-800-679-4776.

You should run a system test several times before concluding that there is a problem. Occasional fluctuations in the phone line or satellite signal can give temporary false readings.

## Fine-Tuning the Signal

If you self-installed your satellite dish antenna, you may have already used the interactive setup to find the dish pointing coordinates, acquire and fine-tune the signal, and run a system test.

If you need to run the interactive setup again, select *Options* from the Main menu, then select *Interactive Setup*.

If you just want to check your dish pointing coordinates, or run the signal strength meter, select *Dish Pointing* from the Main menu.

# Tips & Troubleshooting

## How Signal Flow works

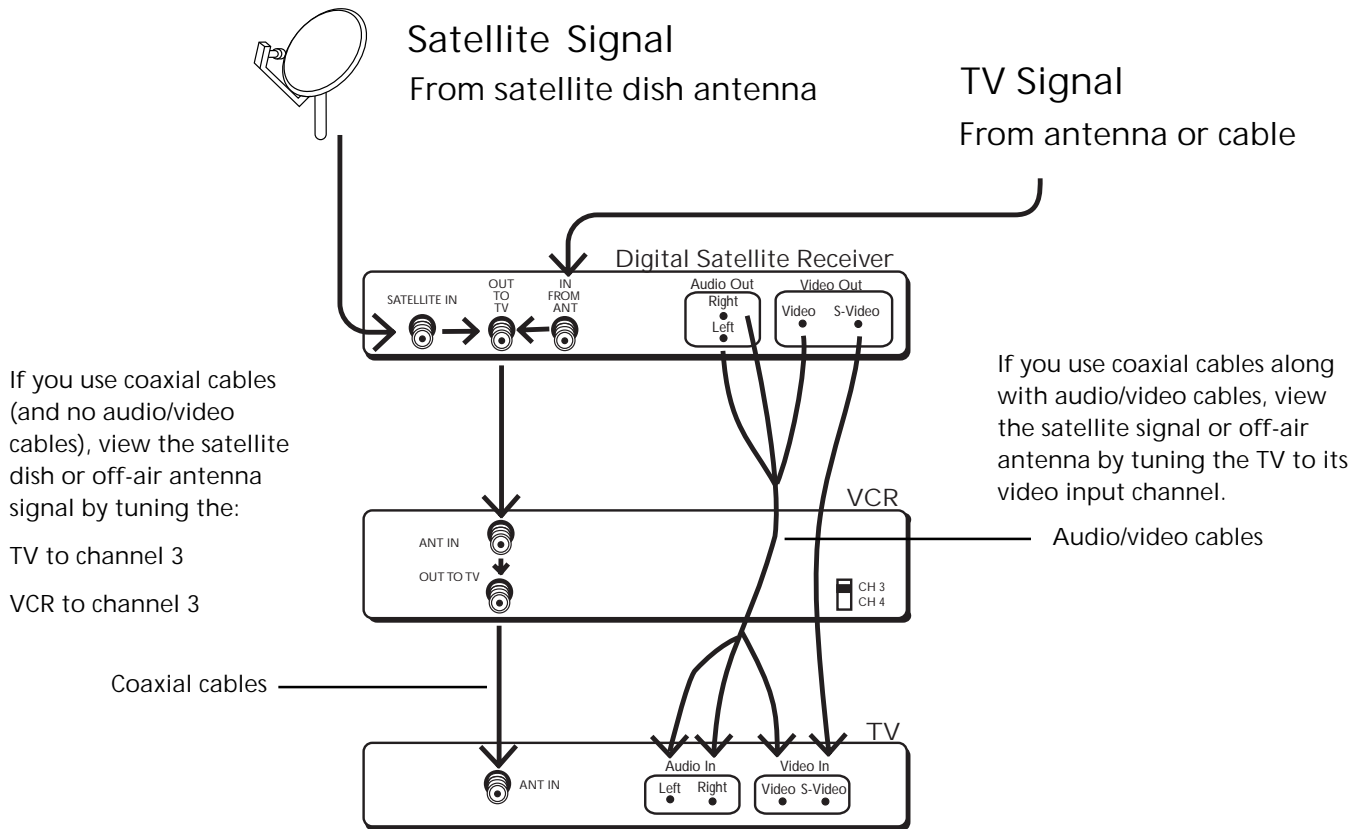

### How the Satellite Signals get to Your TV

In the example above:

1. Program providers send signals to your satellite dish antenna.
2. The satellite dish antenna sends the signal to the digital satellite receiver's SATELLITE IN jack.
3. The signal continues through the coaxial cable to the VCR and then to the TV. (The VCR may seem like an unnecessary link in the chain, but this setup lets you record programming and off-air antenna/cable programming.)

If you use audio/video cables, the satellite signal also flows through the audio/video cables to the TV's line inputs (left, right, and video or S-video).

### How Off-Air Antenna/Cable Signals get to Your TV

In the example above:

1. Off-air/cable broadcasters send signals to your off-air antenna or through cable to your home.
2. The signal continues through the coaxial cable to the receiver and then to the VCR. The signal can also pass through the VCR to the TV. (The VCR may seem like an unnecessary link in the chain, but this setup lets you record programming and off-air antenna/cable programming.)

# Tips & Troubleshooting

## Wrong picture

The digital satellite receiver and most VCRs let you toggle between pictures: one is the picture from the digital satellite receiver and one is from the VCR. If you don't see the picture you think you should be seeing, try using these buttons to toggle between the pictures:

- Press the TV/VCR button on the VCR remote control or on the VCR's front panel.
- Press the ANTENNA button on the remote control.

Taking either of these actions lets you switch the source of the video signal from satellite to the off-air antenna or cable, and vice versa.

## Problems with the remote control

- Maybe something is between the remote control and the remote sensor.
- Maybe the remote is not in satellite mode. Press the DIRECTV button so the remote will control the digital satellite receiver.
- Maybe the batteries in the remote are weak, dead or installed incorrectly. Try replacing batteries. (Note, if you remove the batteries, you may have to reprogram the remote to control other components.)
- Remove the batteries and hold the number 1 button for at least 60 seconds to drain the microprocessor inside the remote. Release the button, replace the batteries, and (if necessary) reprogram the remote.
- Remove all batteries for approximately 12 hours. Then replace batteries and (if necessary) reprogram the remote.

## Blank screen

- Maybe the device (VCR, receiver, DVD, etc.) connected to the input jacks is not on.
- Try another channel, because there may just not be any programming on at that time.

## Receiver will not turn on

- Check to make sure it is plugged in.
- Check the wall receptacle (and extension cord, if applicable) to make sure it is "live" by plugging in something else.
- Maybe batteries in remote control are "dead."
- Maybe remote control is not aimed at remote sensor.
- The front panel controls may be locked (disabled). Use the remote control to unlock the front panel controls by selecting the *Front Panel Lockout* in the Parental Controls menu and choosing *Unlock*.

## LED Light Flashes on front panel

- You have mail. Read the message by selecting *Mailbox* from the Main Menu and selecting the message. Flashing will stop.

## Turns off while playing

- Schedule off function may have been activated.
- Electronic protection circuit may have been activated because of a power surge. Wait 30 seconds and then turn on again. If this happens frequently, the voltage in your house may be abnormally high or low.

## TV Turns on or changes channels unexpectedly

- Scheduled Watch from the Timers menu may have been activated.



# Appendix A: Warranty Information

## Repair Help

Thomson Consumer Electronics offers hardware repair service should you encounter any problems with your DIRECTV System. Many problems can be diagnosed over the phone, or if necessary, a replacement unit can be shipped to you. Please have your DIRECTV System model, serial number and date of purchase ready when you call. If your unit is out of warranty, we will quote the cost of an exchange unit to you. Refer to RCA Limited Warranty for the repair service phone number.

## Returning Equipment to Thomson for Repair or Exchange

If we are unable to resolve your problem over the phone we will gladly service your unit or exchange it for a new or refurbished unit. Refer to the limited warranty included in the booklet to learn about your specific rights and responsibilities. *Always consult Thomson and get a Return Authorization number before returning anything.* Obtain a Return Authorization (RA) number from the telephone representative before returning your equipment to avoid delays, accounting errors, or even loss of your unit.

## Important Information to Customers Who Ship Defective Equipment to Thomson Consumer Electronics

The Thomson representative who authorizes the return of your equipment will give you an RA number over the phone. The representative will also provide you with instructions on where and how to return your unit. Write the number in large, clear characters on the outside of the box. *To avoid confusion and misunderstandings, shipments without an RA number clearly visible on the outside of the box will be returned to you at your expense.*

Include a brief note describing the problem and any conversations you have had with Thomson personnel about the problem. Include your name, address and model/serial number of your unit. These numbers are located on the back of your digital satellite receiver. If your DIRECTV System is within the warranty period, please provide a copy of the bill of sale to verify purchase date. Use the original box and packing material to protect the equipment from damage in shipment. *For your protection, insure all shipments for full replacement value and use a reliable shipper.* Thomson assumes no responsibility for warranty shipments from the customer to the factory if not shipped in the manner prescribed by Thomson.

## RCA SATELLITE SYSTEM LIMITED WARRANTY

### What your warranty covers:

- Any defect in materials or workmanship.

### For how long after your purchase:

- 90 days - Unit exchange, which includes parts and labor.
- 91 days to 1 year - Unit exchange, which includes parts only; you pay the labor.
- The warranty for rental units begins with the first rental or 45 days from date of shipment to the rental firm, whichever comes first.

### What we will do:

- During the initial 90 days:  
Exchange the defective portion of your digital satellite receiver with a new or, at our option, refurbished unit.
- After the 90 days and within one year:  
Exchange the defective portion of your digital satellite receiver with a new or, at our option, refurbished unit. We will charge you a flat exchange cost to replace a defective receiver. This charge covers the labor cost for its repair.

# Appendix A: Warranty Information

## How you get service:

- Call 1-800-679-4776 and have your unit's date of purchase and model/serial number ready. The model/serial number information is on the back of your digital satellite receiver.
- A representative will troubleshoot your problem over the phone.
- If the representative determines that you should receive a replacement digital satellite receiver you will be provided with a Return Authorization (RA) number and the location of a nearby exchange point if one exists. No returns will be accepted without the RA number.
- If the representative determines that your satellite dish antenna is defective he or she will arrange for its repair or replacement.

## Option 1

1. Provide your Discover, Mastercard or Visa account number and expiration date to your phone representative. This is for security purposes only and your account will not be charged at this time.
2. We will send you a replacement unit.
3. If you return the unit to us within 14 days from the date you were provided a RA number, only items not covered by warranty will be charged to your account. If your unit is not received within 14 days, the suggested retail value of the receiver will be charged to your credit card. This amount will be credited, less a \$10 handling fee, if the unit is subsequently received.
4. Ship your defective unit back to us using the replacement unit's carton. Shipping instructions will be included on the carton along with your RA number which will allow you to easily ship the unit back to us. Make sure you insure your shipment in case of damage or loss. Include with the shipment:
  - Evidence of purchase date such as a bill of sale.
  - A brief note describing your digital satellite receiver problem.
  - Your name, address and phone number.

## Option 2

1. We will send a replacement unit to our exchange point.
2. The exchange location will notify you of its arrival.
3. Take your unit and evidence of purchase date, such as a bill of sale, to the exchange location and you will be provided the new or refurbished unit. Please retain all accessories such as the remote control hand unit.
4. If the repairs are covered by your warranty, you will not be billed.

Thomson assumes no responsibility of warranty shipments from the customer to the factory if not shipped in the manner prescribed by Thomson.

## To receive a replacement digital satellite receiver after we have received your unit:

- Write the RA number on the outside of the carton used to return the unit. Make sure you insure your shipment in case of damage or loss.
- Carefully pack the unit using the original box and packing material if possible. Please retain all accessories that were included with your unit such as the remote control hand unit.
- Include with the shipment:
  1. Evidence of purchase date such as a bill of sale.
  2. A brief note describing your digital satellite receiver problem.
  3. Your name, address and phone number.
- The representative will advise the address to mail a cashier's check or money order for payment if there are any out of warranty labor or parts charges, and you elect not to use your credit card.
- After we receive your product, a new or refurbished unit will be shipped to you.

# Appendix A: Warranty Information

## What your warranty *does not* cover:

- Acts of God, such as but not limited to lightning damage.
- Adjustment of customer controls.
- Damage from misuse or neglect.
- A unit that has been modified or incorporated into other products or is used for institutional or other commercial purposes.
- Batteries.
- Units purchased, serviced or operated outside the U.S.A. and Alaska.
- For units intended for use in Alaska, this warranty does not cover installation or the dish antenna. It only covers the digital satellite receiver.
- Loss of programming.
- Installation.
- Shipping damage if the unit was not packed and shipped in the manner prescribed by Thomson.
- Storage fees may be charged by the exchange point if you fail to pickup the replacement unit in a timely manner.

## Product Registration:

- Please complete and mail the Product Registration Card packed with your product. It will make it easier to contact you should it ever be necessary. The return of the card is not required for a warranty coverage.

## How state law relates to warranty:

- This warranty gives you specific legal rights and you may have other rights that vary from state to state.

## If you purchased your product outside the United States:

- This warranty does not apply. See your dealer for warranty information.

# Appendix B: FCC Regulations

## FCC Registration Information

Your satellite system equipment is registered with the Federal Communications Commission and is in compliance with parts 15B and 68, FCC Rules and Regulations.

### 1. Notification to the Local Telephone Company.

On the bottom of this equipment is a label indicating among other information, the FCC Registration number and Ringer Equivalence Number (REN) for the equipment. You must, upon request, provide this information to your telephone company.

The REN is useful to determine the number of devices you may connect to your telephone line and still have all these devices ring when your telephone number is called. In most (but not all) areas, the sum of the RENs of all devices connected to one line should not exceed 5. To be certain of the number of devices you may connect to your line as determined by the REN, you should contact your local telephone company.

Note: This equipment may not be used on coin service provided by the telephone company. Party lines are subject to state tariffs, and therefore you may not be able to use your own telephone equipment if you are on a party line. Check with your local telephone company.

Notice must be given to the telephone company upon permanent disconnection of your equipment from your line.

### 2. Rights of the Telephone Company.

Should your equipment cause trouble on your line which may harm the telephone network, the telephone company shall, where practicable, notify you that temporary discontinuance of service may be required. Where prior notice is not practicable and the circumstances warrant such action, the telephone company may temporarily discontinue service immediately. In case of such temporary discontinuance, the telephone company must: (1) promptly notify you of such temporary discontinuance (2) afford you the opportunity to correct the situation and (3) inform you of your right to bring a complaint to the Commission pursuant to procedures set forth in Subpart E of Part 68, FCC Rules and Regulations.

The telephone company may make changes in its communications facilities, equipment, operations of procedures where such action is required in the operation of its business and not inconsistent with FCC Rules and Regulations. If these changes are expected to affect the use or performance of your telephone equipment, the telephone company must give you adequate notice, in writing, to allow you to maintain uninterrupted service.

## Radio Interference

This equipment has been type tested and found to comply with the limits for a Class B Digital Device in accordance with the specifications in Part 15 of FCC Rules. These rules are designed to provide reasonable protection against radio and television interference in a residential installation. This equipment generates, uses and can radiate radio frequency energy and, if not installed and used in accordance with the instructions, may cause harmful interference to radio communications. However, there is no guarantee that interference will not occur in a particular installation.

If this equipment does cause interference to radio or television reception (which you can determine by turning the equipment off and on), try to correct the interference by one or more of the following measures:

- Reorient or relocate the receiving antenna (that is, the antenna for radio or television that is "receiving" the interference).
- Change the position of the satellite receiver with respect to the radio or television equipment that is receiving interference.
- Move the satellite receiver away from equipment receiving interference.
- Plug the satellite receiver into a different wall outlet so the receiver and equipment receiving interference are on different branch circuits.

If these measures do not eliminate interference, please consult your dealer or an experienced radio/television technician for additional suggestions. Also, the Federal Communications Commission has prepared a helpful booklet, "How To Identify and Resolve Radio/TV Interference Problems". This booklet is available from the U.S. Government Printing Office, Washington, D.C. 20402. Please specify stock number 004-000-00345-4 when ordering copies.

# Appendix C: Accessories

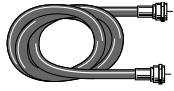

RG-6 Coaxial Burial Cable with weatherproof "F" connectors

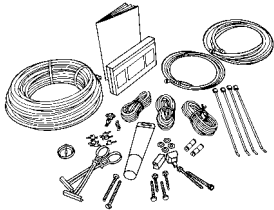

Self-Installer's Kit contains cable and hardware to install the satellite dish antenna and connect the DIRECTV system.

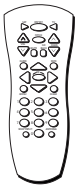

Remote Control replaces a lost remote. Or, order a second remote for convenience.



HCDSS10 Home Control Kit contains a Data Interface that connects to the digital satellite receiver and a lamp module.



HC10LM Lamp module lets you control incandescent lamps. Use to dim/brighten and turn lamps on/off.



HC20AM or HC30AM Appliance modules turn small appliances, like coffee pots, popcorn makers, or stereo, on or off. Also controls non-incandescent lamps. Choose 2 prong (HC20AM) or 3 prong (HC30AM).



Detach Here

## Accessory Order Form for the DIRECTV System

Description	Part No.	Price	Qty
RG-6 Coaxial Cable			
12 feet	D912	\$12.95	
25 feet	D925	\$15.95	
50 feet	D950	\$21.95	
75 feet	D975	\$29.95	
100 feet	D901	\$35.95	
S-Video Cable 12 feet	D913	\$12.95	
Weatherproof "F" Connector (2)	D905	\$ 5.30	
TVRO Bullet Amplifier	D903	\$24.95	
Self-Installer's Kit	DKIT96	\$69.95	
Remote Control	240968	\$34.95	
Home Control Kit	HCDSS10	\$59.95	
Lamp Module	HC10LM	\$14.95	
2-Prong Appliance Module	HC20AM	\$16.95	
3-Prong Appliance Module	HC30AM	\$16.95	

Prices are subject to change without notice.

Total Merchandise ..... \$ \_\_\_\_\_

Sales Tax ..... \$ \_\_\_\_\_

We are required by law to collect the appropriate sales tax for each individual state, country, and locality to which the merchandise is being sent.

Shipping, Handling, and Insurance ..... \$ 5.00

Total Amount Enclosed ..... \$ \_\_\_\_\_

Use VISA, MasterCard, or Discover preferably.

Money order or check must be in U.S. currency only.

No COD or CASH.

All accessories are subject to availability.

Please complete other side also

# Appendix C: Accessories

Charge your order on your VISA, MasterCard, or Discover Card by filling in below

**USE YOUR CREDIT CARD**

**IMPORTANT:** Copy complete account number from your VISA card



My card expires:

**IMPORTANT:** Copy complete account number from your MasterCard



Copy Number above your name on MasterCard     My card expires:

**IMPORTANT:** Copy complete account number from your Discover Card



My card expires:

---

**AUTHORIZED SIGNATURE**  
 (Credit card order will not be processed without signature)  
 Prices are subject to change without notice.

Print or type your name and address clearly.



A complete and correct order will save you days of waiting.

Name: \_\_\_\_\_

Street: \_\_\_\_\_

\_\_\_\_\_ Apt: \_\_\_\_\_

City: \_\_\_\_\_

State: \_\_\_\_\_ Zip: \_\_\_\_\_

Please make sure that both sides of this form have been filled out completely.

- Allow 4 weeks for delivery.
- All accessories are subject to availability.
- Prices are subject to change.

## United States and Canada Orders

To place your order by phone, have your Visa, MasterCard or Discover Card ready and call the toll-free number listed below between 8AM and 10PM (EST) Monday through Friday or between 9AM and 5PM (EST) Saturday.

Use this number only to place an order for accessory items listed on this order form.

1-800-338-0376

To place your order by mail, detach and mail the completed order form with credit card information, money order or check in US currency (made payable to Thomson Consumer Electronics, Inc.) to the following address:

Video Accessories  
 PO Box 8419  
 Ronks, PA 17573

# Index

- A**
  - Access Card
    - entry 43
    - number 10
  - Accessories 59
  - All button 24
  - AlphaSort button 24
  - Alternate data 43
  - Attractions Guide 21, 33
  - Audio Language 43
- B**
  - Back panel controls 6
  - Batteries
    - installing in remote 10
  - Buttons 12
- C**
  - Cancelling purchases 35
  - Channel banner 17
    - anatomy 17
    - icons 17
  - Channel Guide 18
  - Channel lists 37
    - add channels 37
    - delete channels 37
  - Codes 13
  - Connections 7-8
    - audio/video quality 8
    - jacks and cables 5
- D**
  - Data port 17, 46
  - Default guide 18
  - Detail Guide 18
  - Digital satellite receiver
    - back panel 6
    - connecting 7-8
  - DIRECTV button 12, 28, 52, 54
  - Dish Pointing 44
    - azimuth 44
    - elevation 44
    - menu 44
- E**
  - Exiting
    - menus 28, 29
    - program guides 16, 20
- F**
  - Fetch
    - button 50
    - customizing 48-49
    - menu 49
  - Front panel controls 6, 12
- G**
  - Glossary 42
  - Grid Guide 18
  - GUIDE button 16, 18
- H**
  - Help 26
  - Home Control 46
    - accessories 46, 59
    - icon 17
    - menu 46
    - setup 46
    - timers 47
- I**
  - Icons 16, 40, 47
  - Interactive setup 10
- L**
  - Light on front panel 31, 54
  - Locking
    - a profile 39
    - the system 40
  - Logo Guide 20
  - Look and feel 42
- M**
  - Mailbox
    - checking your mail 31, 54
    - icon 17
  - Main menu 28
  - Menu system 28
    - exit 28
    - help 28
    - navigation 13
  - Menus
    - Dish Pointing 44
    - Fetch 48
    - Home Control 46
    - Mailbox 31
    - Options 43
    - Profiles 36
    - Program Guide 16
    - Purchases 32
    - Timers 36
  - Movies button 23
- O**
  - Options menu 41
  - Other Guides
    - Attractions Guide 21
    - button 21
- P**
  - Passwords 32
  - Pay-per-view programs 32
    - tuning to 32
  - Power (on/off) 12, 54
  - Profiles
    - channel lists 37
    - choosing 41
    - locking 39
    - menu 29, 38
    - ratings limits 37
    - spending limits 39
    - unlocking 40
    - viewing hours 38
  - Program guides 16, 18
    - anatomy 16
    - Attractions Guide 21
    - buttons 18
    - Channel Guide 18
    - default 18
    - Detail Guide 18
    - exiting 18
    - Grid Guide 18
    - Logo Guide 20
    - scrolling 18
    - sorting 22
    - SurfGuide 18
  - Programming the Remote 13
    - to control a TV 13
  - Purchases 32
    - cancelling 35
    - menu 34
    - reviewing 35
    - spending limits 35
- R**
  - Ratings limit 37
  - Remote control
    - batteries 10
    - buttons 12
    - programming 13
  - Reviewing purchases 35
- S**
  - Scout 25
  - Screen, blank 54
  - Scrolling 18
  - Signal meter 45
    - peak signal 44
  - Sorting
    - program guides 22
  - Sorting by
    - All button 22
    - AlphaSort button 24
    - Movies button 23
    - Other Guides button 20
    - Scout button 25
    - Sports button 22
    - Topics button 21
  - Spending limits 35, 38
  - Sports button 24
  - SurfGuide 18
  - System Info 42
  - System lock 40
  - System options 42
  - System test 43, 53
  - System unlock 40
- T**
  - Timer feature
    - editing or cancelling 36, 54
  - Timers
    - Home Control 47
    - icons 46
  - Timers menu 36
  - Topics button 23
  - Troubleshooting 52
  - Tuning to a program 19
- U**
  - Unlocking
    - a profile 39
    - the system 40
- V**
  - Viewing hours limit 38
- W**
  - Warranty information 55

If your DIRECTV System needs service, please contact your dealer or the nearest Service Center from the Yellow Pages. Please do not send any products to the Indianapolis address listed in this manual or on the carton. This will only add delays in service for your product.

10330 North Meridian Street  
Indianapolis, IN 46290

 **THOMSON CONSUMER ELECTRONICS**

©1999 Thomson Consumer Electronics, Inc.

Trademark(s)® Registered

Marca(s) Registrada(s)

DIRECTV is a trademark of DIRECTV, Inc., a unit of Hughes Electronics, and is used with permission.

Printed in USA

TOCOM 1535141A



100%

**RECYCLED PAPER**

**MINIMUM 40% POST CONSUMER**

